

**Hybrid**  
**2010 Model**  
**3<sup>rd</sup> Generation**  
*Emergency Response Guide*



© 2009 Toyota Motor Corporation  
All rights reserved. This document may not be  
altered without the written permission of Toyota Motor Corporation.

10 Prius ERG REV – (03/05/09)

## Foreword

In May 2000 and October 2003, Toyota introduced the 1<sup>st</sup> and 2<sup>nd</sup> generation Toyota Prius gasoline-electric hybrid vehicles in North America. To educate and assist emergency responders in the safe handling of Toyota Prius technology, Toyota published the 2000 and 2004 Toyota Prius Emergency Response Guides.

With the release of the 3<sup>rd</sup> generation Toyota Prius in March 2009, a new 2010 Toyota Prius Emergency Response Guide was published for emergency responders. While many features from the 1<sup>st</sup> and 2<sup>nd</sup> generation Prius models are similar, emergency responders should recognize and understand the new, updated features of the Prius covered in this guide.

High voltage electricity powers the electric motor, generator, air conditioning compressor and inverter/converter. All other automotive electrical devices such as the headlights, radio, and gauges are powered from a separate 12 Volt auxiliary battery. Numerous safeguards have been designed into the Prius to help ensure the high voltage, approximately 201.6 Volt, Nickel Metal Hydride (NiMH) Hybrid Vehicle (HV) battery pack is kept safe and secure in an accident.

The Prius utilizes the following electrical systems:

- Maximum 650 Volts AC
- Nominal 201.6 Volts DC
- Nominal 12 Volts DC

3<sup>rd</sup> generation Prius Features:

- Complete model change with a new exterior and interior design.
- A boost converter in the inverter/converter that boosts the available voltage to the electric motor to 650 Volts.
- A high voltage Hybrid Vehicle (HV) battery pack rated at 201.6 Volts.
- A high voltage motor driven Air Conditioning (A/C) compressor rated at 201.6 Volts.
- An optional solar ventilation system and remote air conditioning system.

- A body electrical system rated at 12 Volts, negative chassis ground.
- Supplemental Restraint System (SRS) – dual stage frontal airbags, front seat mounted side airbags, side curtain airbags, front seatbelt pretensioners, and driver knee airbag.

High voltage electrical safety remains an important factor in the emergency handling of the Prius Hybrid Synergy Drive. It is important to recognize and understand the disabling procedures and warnings throughout the guide.

Additional topics in the guide include:

- Prius identification.
- Major Hybrid Synergy Drive component locations and descriptions.
- Extrication, fire, recovery, and additional emergency response information.
- Roadside assistance information.

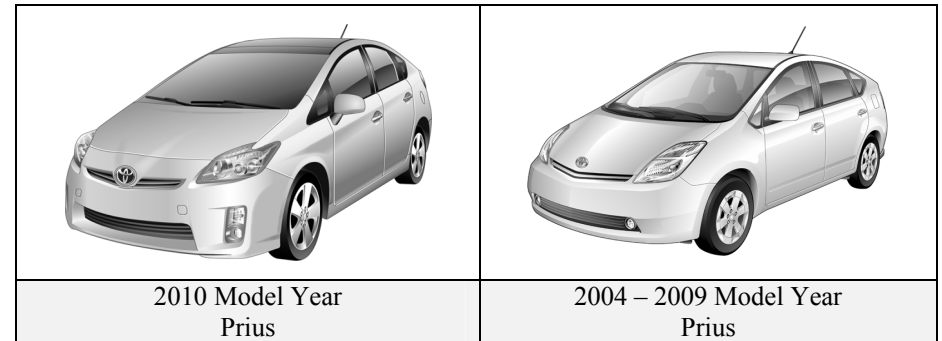

This guide is intended to assist emergency responders in the safe handling of a Prius vehicle during an incident.

<b>Table of Contents</b>	<b>Page</b>
About the Prius	1
Prius Identification	2
Hybrid Synergy Drive Component Locations & Descriptions	5
Smart Key System	8
Electronic Gearshift Selector	10
Hybrid Synergy Drive Operation	11
Hybrid Vehicle (HV) Battery Pack	12
Solar Ventilation and Remote Air Conditioning Systems	13
Low Voltage Battery	15
High Voltage Safety	16
SRS Airbags & Seat Belt Pretensioners	17
Emergency Response	19
Extrication	19
Fire	26
Overhaul	27
Recovering/Recycling of NiMH HV Battery Pack	27
Spills	28
First Aid	28
Submersion	29
Roadside Assistance	30

## About the Prius

The Prius continues into its 3<sup>rd</sup> generation as a gasoline-electric hybrid vehicle. Hybrid Synergy Drive means that the vehicle contains a gasoline engine and electric motor for power. The two hybrid power sources are stored on board the vehicle:

1. Gasoline stored in the fuel tank for the gasoline engine.
2. Electricity stored in a high voltage Hybrid Vehicle (HV) battery pack for the electric motor.

The result of combining these two power sources is improved fuel economy and reduced emissions. The gasoline engine also powers an electric generator to recharge the battery pack; unlike a pure all electric vehicle, the Prius never needs to be recharged from an external electric power source.

Depending on the driving conditions one or both sources are used to power the vehicle. The following illustration demonstrates how the Prius operates in various driving modes.

- ❶ During light acceleration at low speeds, the vehicle is powered by the electric motor. The gasoline engine is shut off.
- ❷ During normal driving, the vehicle is powered mainly by the gasoline engine. The gasoline engine also powers the generator to recharge the battery pack.

- ❸ During full acceleration, such as climbing a hill, both the gasoline engine and the electric motor power the vehicle.
- ❹ During deceleration, such as when braking, the vehicle regenerates the kinetic energy from the front wheels to produce electricity that recharges the battery pack.
- ❺ While the vehicle is stopped, the gasoline engine and electric motor are off, however the vehicle remains on and operational.

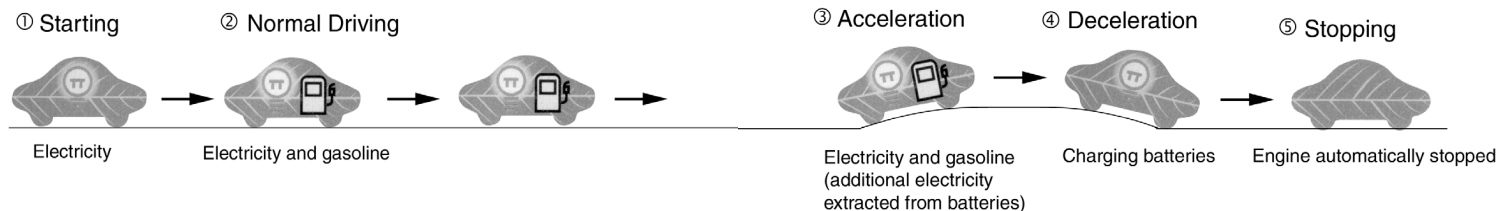

## Prius Identification

In appearance, the 2010 model year Prius is a 5-door hatchback. Exterior, interior, and engine compartment illustrations are provided to assist in identification.

The alphanumeric 17 character Vehicle Identification Number (VIN) is provided in the front windshield cowl and on the driver door pillar.

Example VIN: JTDKN36UA82020211

A Prius is identified by the first 8 alphanumeric characters **JTDKN36U**.

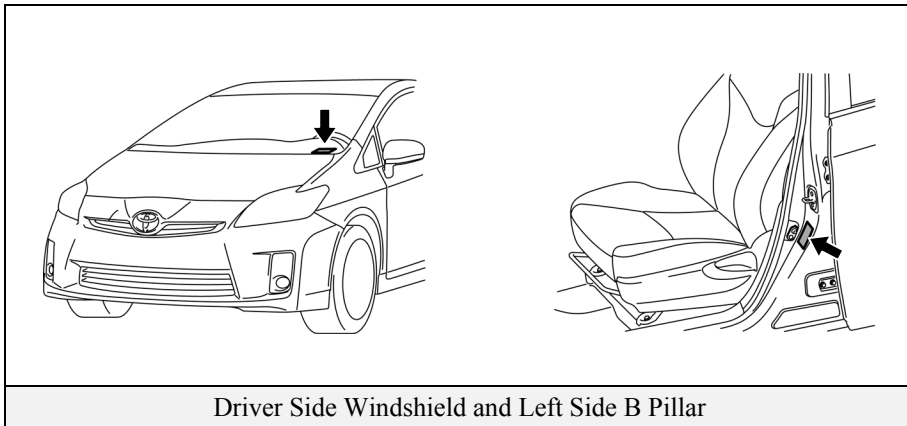

## Exterior

- 1 **PRIUS** and  logos on the back door.
- 2 Gasoline fuel filler door located on driver side rear quarter panel.

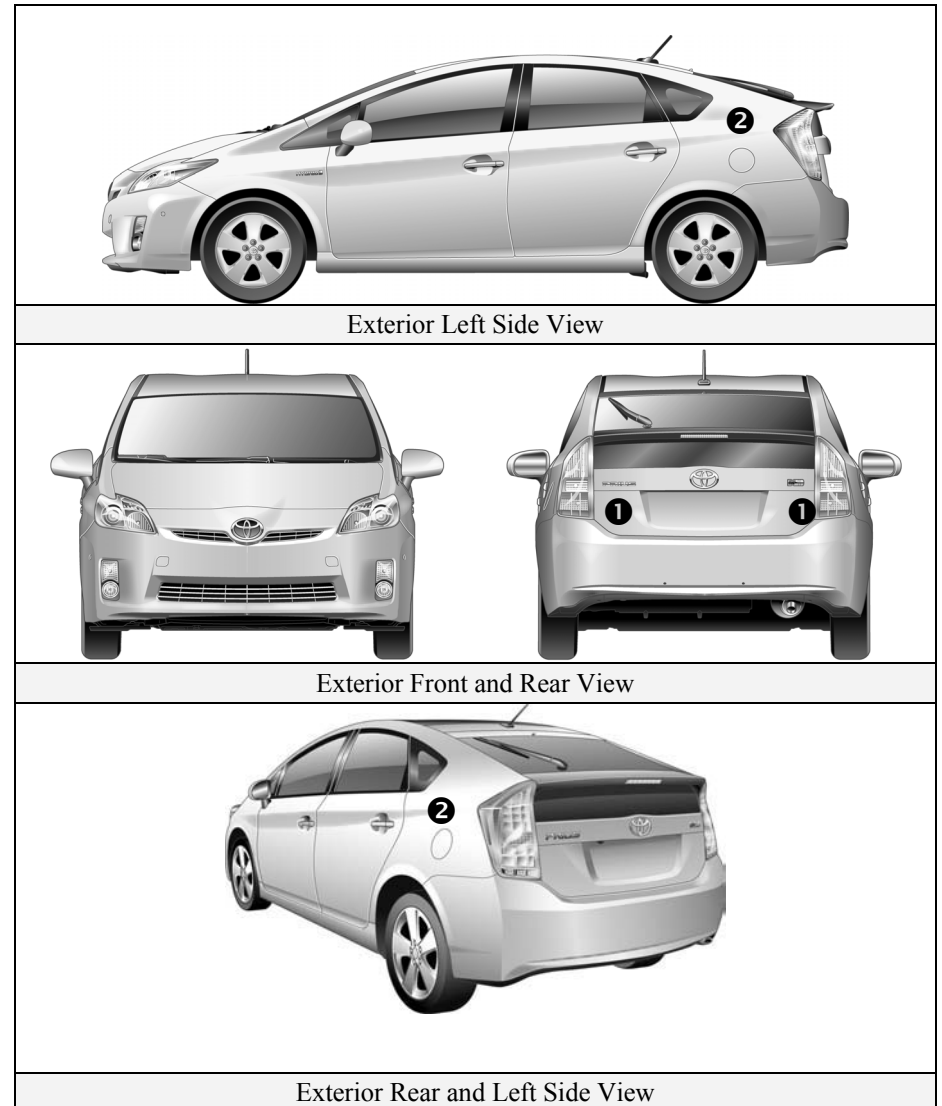

## Prius Identification (Continued)

### Interior

- ③ Instrument cluster (speedometer, **READY** light, shift position indicators, warning lights) located in center of the dash and near the base of the windshield.

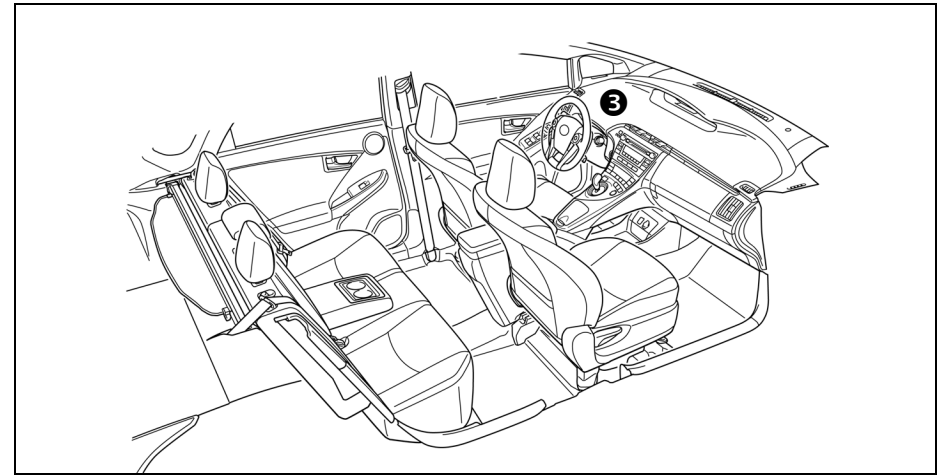

Interior View

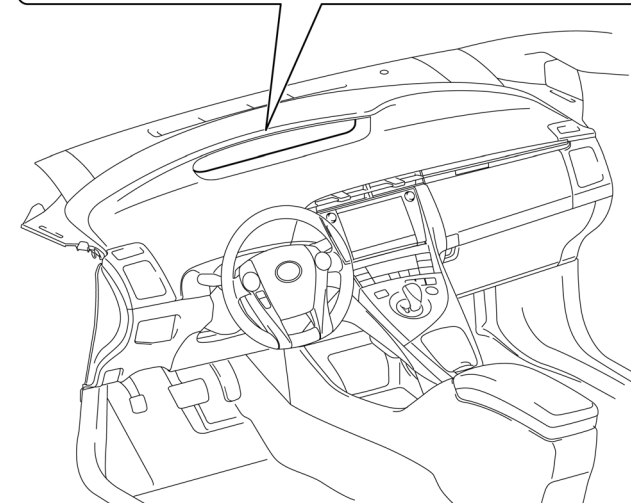
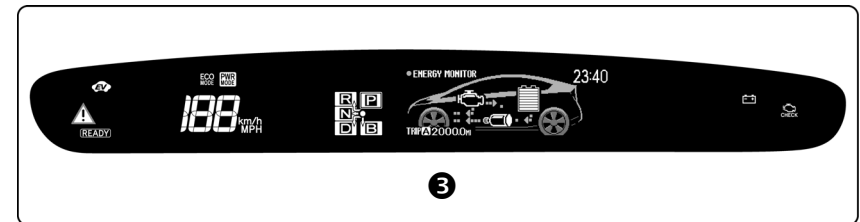

Instrument Cluster View

## Prius Identification (Continued)

### Engine Compartment

- ④ 1.8-liter aluminum alloy gasoline engine.
- ⑤ Logo on the plastic engine cover.

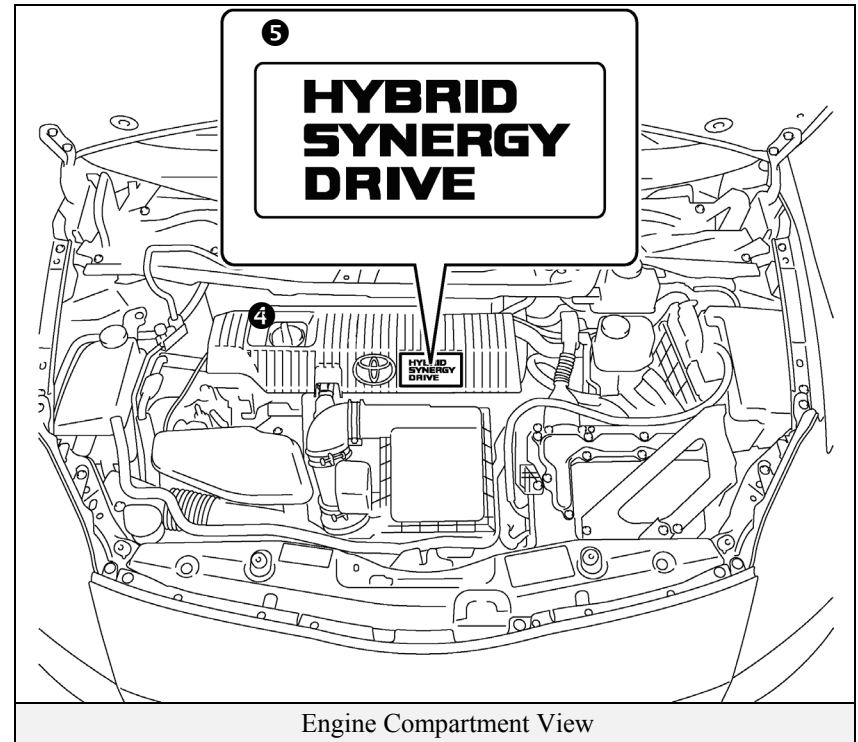

## Hybrid Synergy Drive Component Locations & Descriptions

Component	Location	Description
12 Volt Auxiliary Battery ❶	Right Side of Cargo Area	A lead-acid battery that supplies power to the low voltage devices.
Hybrid Vehicle (HV) Battery Pack ❷	Cargo Area, Mounted to Cross Member behind Rear Seat	201.6 Volt Nickel Metal Hydride (NiMH) battery pack consisting of 28 low voltage (7.2 Volt) modules connected in series.
Power Cables ❸	Undercarriage and Engine Compartment	Orange colored power cables carry high voltage Direct Current (DC) between the HV battery pack, inverter/converter, and A/C compressor. These cables also carry 3-phase Alternating Current (AC) between the inverter/converter, electric motor, and generator.
Inverter/Converter ❹	Engine Compartment	Boosts and inverts the high voltage electricity from the HV battery pack to 3-phase AC electricity that drives the electric motor. The inverter/converter also converts AC electricity from the electric generator and electric motor (regenerative braking) to DC that recharges the HV battery pack.
Gasoline Engine ❺	Engine Compartment	Provides two functions: 1) Powers vehicle. 2) Powers generator to recharge the HV battery pack. The engine is started and stopped under control of the vehicle computer.
Electric Motor ❻	Engine Compartment	3-phase high voltage AC permanent magnet electric motor contained in the front transaxle. It is used to power the front wheels.
Electric Generator ❼	Engine Compartment	3-phase high voltage AC generator that is contained in the transaxle and recharges the HV battery pack.

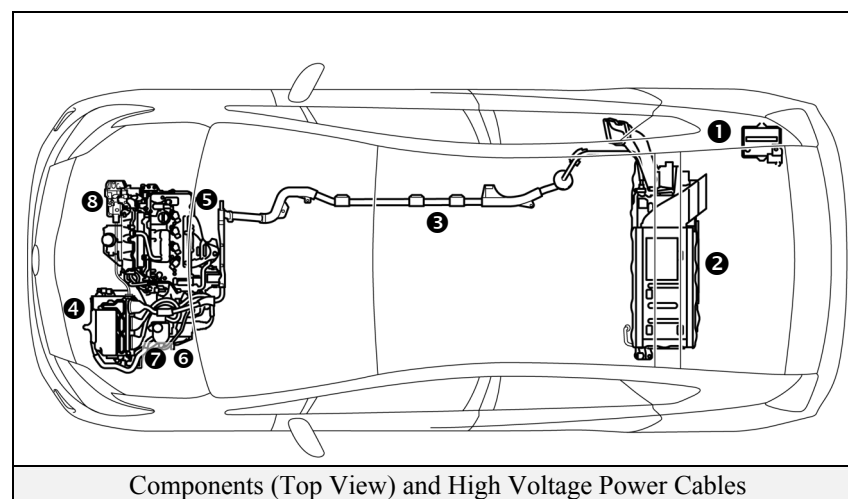
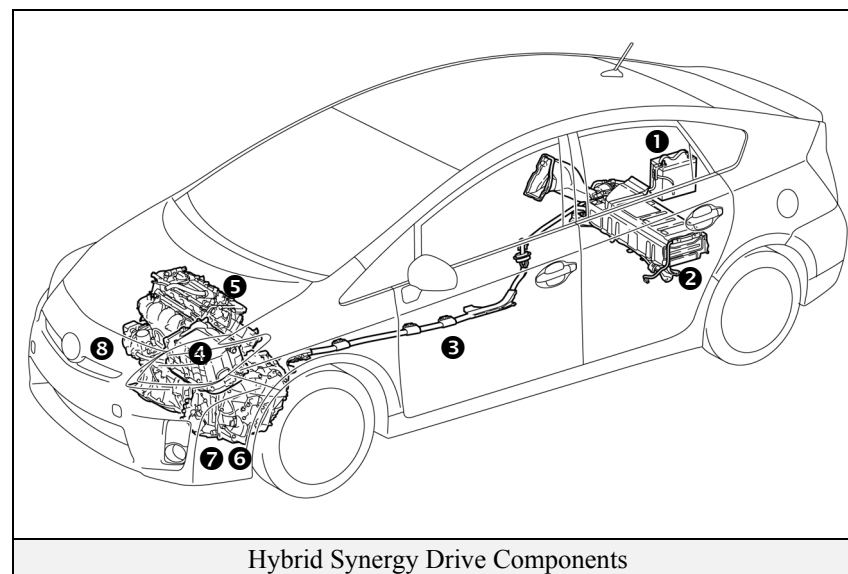



## Hybrid Synergy Drive Component Locations & Descriptions (Continued)

Component	Location	Description
A/C Compressor (with Inverter) ⑧	Engine Compartment	3-phase high voltage AC electrically driven motor compressor.
Fuel Tank and Fuel Line ⑨	Undercarriage and Center	The fuel tank provides gasoline via a fuel line to the engine. The fuel line is routed under the center of vehicle.

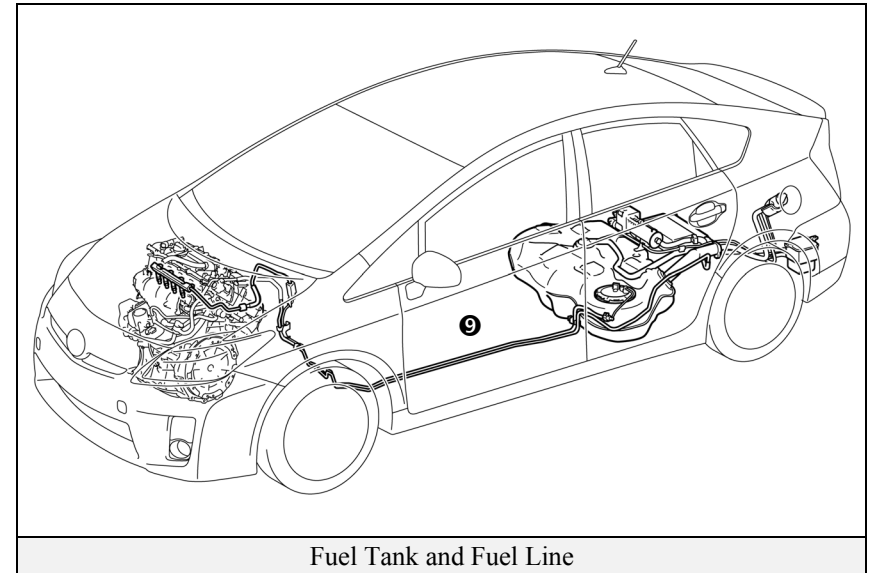

## Hybrid Synergy Drive Component Locations & Descriptions (Continued)

### Key Specifications:

Gasoline Engine:	98 hp (73 kW), 1.8-liter Aluminum Alloy Engine
Electric Motor:	80 hp (60 kW), Permanent Magnet Motor
Transmission:	Automatic Only (electrically controlled continuously variable transaxle)
HV Battery:	201.6 Volt Sealed NiMH-Battery
Curb Weight:	3,080 lbs/1,397 kg
Fuel Tank:	11.9 gals/45.0 liters
Frame Material:	Steel Unibody
Body Material:	Steel Panels except for Aluminum Hood and Back Door

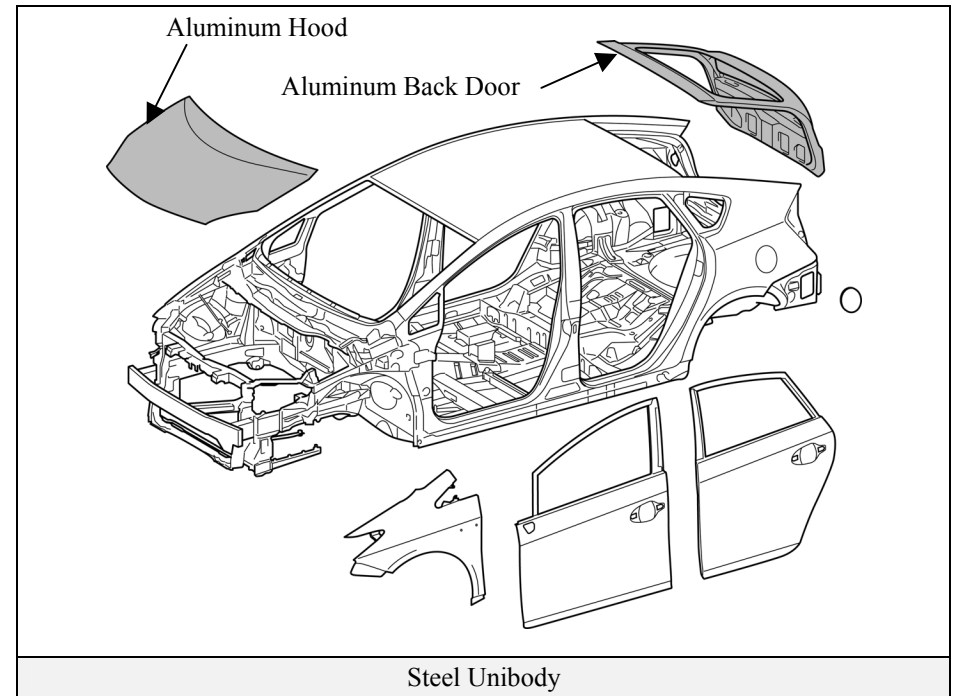

## Smart Key System

The Prius smart key system consists of a smart key transceiver that communicates bi-directionally, enabling the vehicle to recognize the smart key in proximity to the vehicle. Once recognized, the smart key will allow the user to lock and unlock the doors without pushing smart key buttons, and start the vehicle without inserting it into an ignition switch.

Smart key features:

- Passive (remote) function to lock/unlock the doors and start the vehicle.
- Wireless transmitter buttons to lock/unlock all 5 doors.
- Hidden metal cut key to lock/unlock the doors.

### Door (Lock/Unlock)

There are several methods available to lock/unlock the doors.

- Pushing the smart key lock button will lock all doors including the back door. Pushing the smart key unlock button once unlocks the driver door, twice unlocks all doors.
- Touching the sensor on the backside of the driver door exterior handle, with the smart key in proximity to the vehicle, unlocks the driver door. Touching the sensor on the backside of the front passenger door exterior handle, with the smart key in proximity to the vehicle, unlocks all doors. Touching the lock sensor on either front door, or the lock button for the back door will lock all doors.
- Inserting the hidden metal cut key in the driver door lock and turning clockwise once unlocks the driver door, twice unlocks all doors. To lock all doors turn the key counter clockwise once. Only the driver door contains an exterior door lock for the metal cut key.

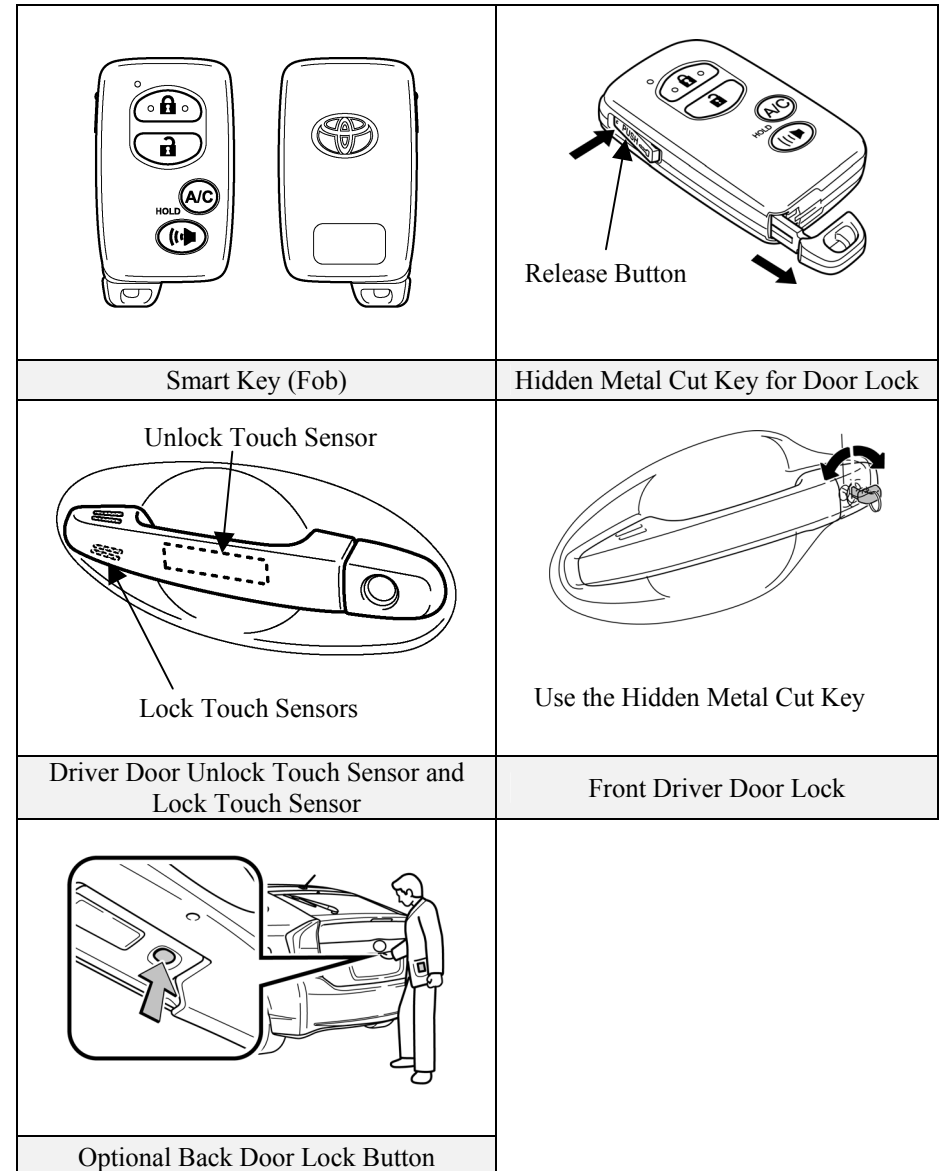

## Smart Key System (Continued)

### Vehicle Starting/Stopping

The smart key has replaced the conventional metal cut key, and the power button with an integral status indicator light has replaced the ignition switch. The smart key only needs to be in proximity to the vehicle to allow the system to function.

- With the brake pedal released, the first push of the power button operates the accessory mode, the second push operates the ignition-on mode, and the third push turns the ignition off again.

Ignition Mode Sequence (brake pedal released):

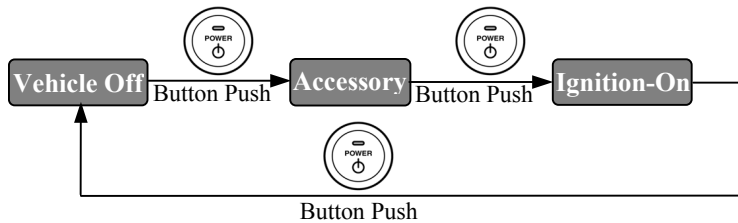

- Starting the vehicle takes priority over all other ignition modes and is accomplished by depressing the brake pedal and pushing the power button once. To verify the vehicle has started, check that the power button status indicator light is off and the **READY** light is illuminated in the instrument cluster.
- If the internal smart key battery is dead, use the following method to start the vehicle.
  1. Touch the Toyota emblem side of the smart key to the power button.
  2. Within the 5 seconds after the buzzer sounds, push the power button with the brake pedal depressed (the **READY** light will illuminate).
- Once the vehicle has started and is on and operational (**READY-ON**), the vehicle is shut off by bringing the vehicle to a complete stop and then depressing the power button once.
- To shut off the vehicle before coming to a stop in an emergency, push and hold down the power button for more than 3 seconds. This procedure may be useful at an accident scene in which the **READY** indicator is on, **Park** cannot be selected, and the drive wheels remain in motion.

Ignition Mode	Power Button Indicator Light
Off	Off
Accessory	Amber
Ignition-On	Amber
Brake Pedal Depressed	Green
Vehicle Started (READY-ON)	Off
Malfunction	Blinking Amber

<p>Power Button with Integral Status Indicator Light</p>	<p>Ignition Modes (Brake Pedal Released)</p>
<p>Starting Sequence (Brake Pedal Depressed)</p>	<p>Smart Key Recognition (When Smart Key Battery is Dead)</p>

## Electronic Gearshift Selector

The Prius electronic gearshift selector is a momentary select shift-by-wire system that engages the transaxle in **R**everse, **N**eutral, **D**rive, or engine **B**rake modes.

- These modes may only be engaged while the vehicle is on and operational (READY-on), except for Neutral which may also be engaged while in the ignition-on mode. After selecting the gear position R, N, D, or B the transaxle remains in that position, identified on the instrument cluster, but the shift selector returns to a default position. To select Neutral, it is necessary to hold the shift selector in the N position for approximately 0.5 seconds.
- Unlike a conventional vehicle, the electronic shift selector does not contain a park position. Instead, a separate **P** switch located above the shift selector engages the park.
- When the vehicle is stopped, regardless of shift selector position, the electro-mechanical parking pawl is engaged to lock the transaxle into park by either depressing the **P** switch or pushing the power button to shut off the vehicle.
- Being electronic, the gearshift selector and the park systems depend on the low voltage 12-Volt auxiliary battery for power. If the 12-Volt auxiliary battery is discharged or disconnected, the vehicle cannot be started and cannot be shifted out of park.

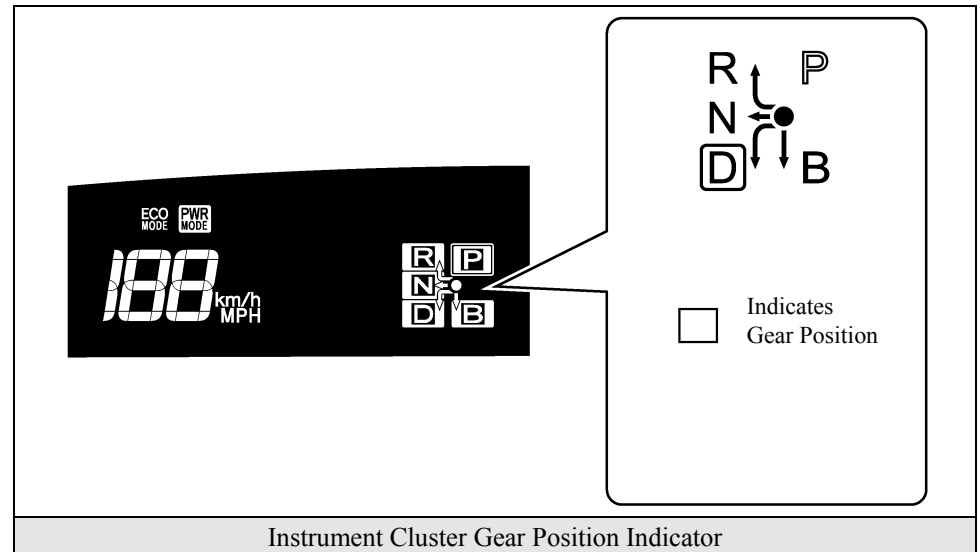
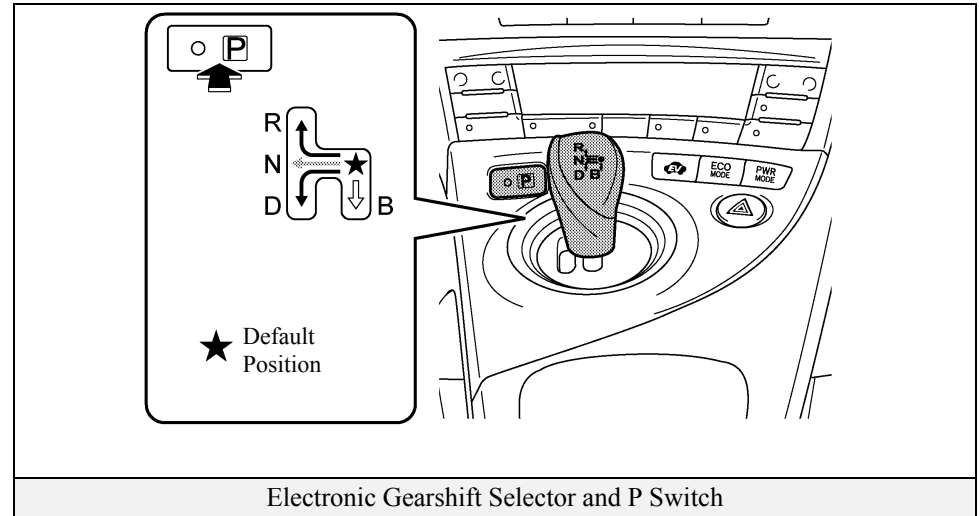

## Hybrid Synergy Drive Operation

Once the **READY** indicator is illuminated in the instrument cluster, the vehicle may be driven. However, the gasoline engine does not idle like a typical automobile and will start and stop automatically. It is important to recognize and understand the **READY** indicator provided in the instrument cluster. When lit, it informs the driver that the vehicle is on and operational even though the gasoline engine may be off and the engine compartment is silent.

### Vehicle Operation

- With the Prius, the gasoline engine may stop and start at any time while the **READY** indicator is on.
- Never assume that the vehicle is shut off just because the engine is off. Always look for the **READY** indicator status. Although the vehicle is shut off when the **READY** indicator is off, the optional remote air conditioning system can still operate using high voltage power from the HV battery pack (see remote air conditioning system description on page 14).
- The vehicle may be powered by:
  1. The electric motor only.
  2. The gasoline engine only.
  3. A combination of both the electric motor and the gasoline engine.
- The vehicle computer determines the mode in which the vehicle operates in order to improve fuel economy and reduce emissions. Three new features on the 2010 Prius are EV (Electric Vehicle) mode, Power mode and ECO (Economy) mode:
  1. EV Mode: When activated, and certain conditions have been met, the vehicle operates with the electric motor powered by the HV battery.
  2. ECO Mode: When activated, this mode helps enhance fuel economy on trips that involve frequent braking and acceleration.
  3. Power Mode: Optimizes acceleration feel by increasing the power output more quickly at the beginning of accelerator pedal operation.

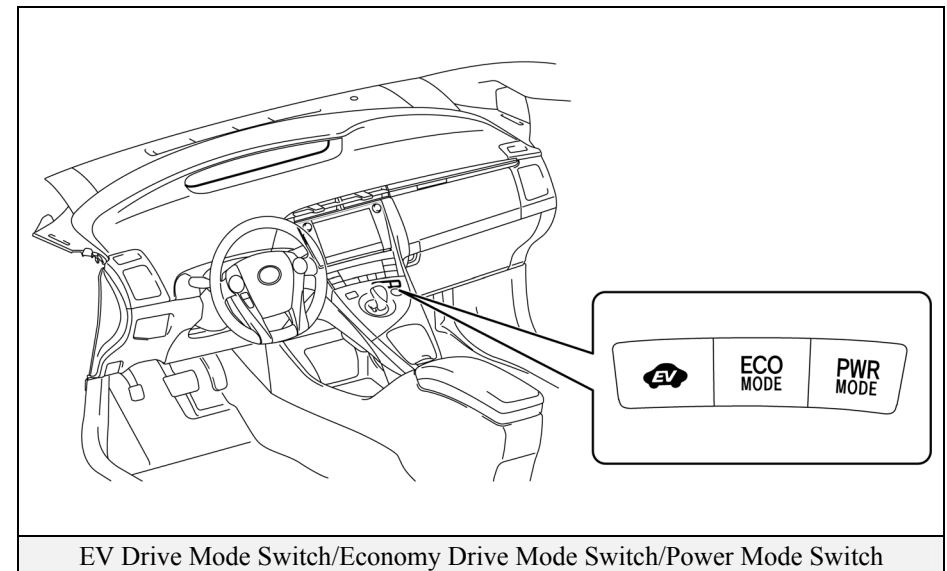
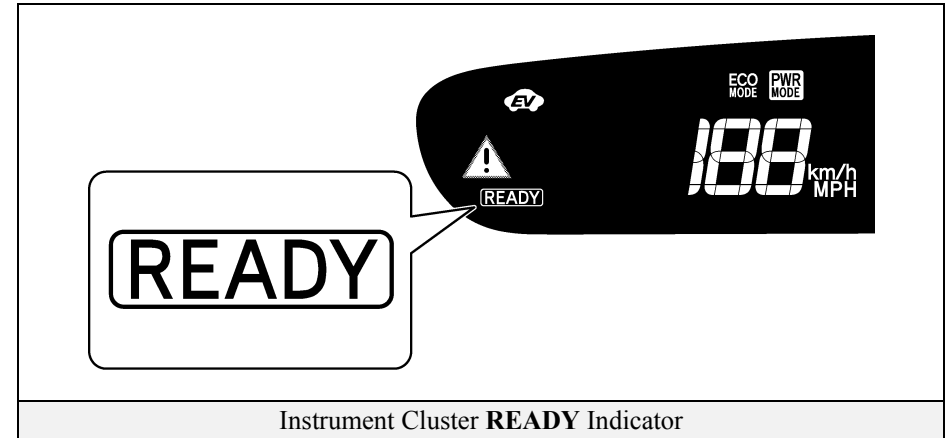

## Hybrid Vehicle (HV) Battery Pack

The Prius features a high voltage Hybrid Vehicle (HV) battery pack that contains sealed Nickel Metal Hydride (NiMH) battery modules.

### HV Battery Pack

- The HV battery pack is enclosed in a metal case and is rigidly mounted to the cargo area floor pan cross member behind the rear seat. The metal case is isolated from high voltage and concealed by carpet in the cabin area.
- The HV battery pack consists of 28 low voltage (7.2 Volt) NiMH battery modules connected in series to produce approximately 201.6 Volts. Each NiMH battery module is non-spillable and in a sealed case.
- The electrolyte used in the NiMH battery module is an alkaline mixture of potassium and sodium hydroxide. The electrolyte is absorbed into the battery cell plates and will not normally leak, even in a collision.

HV Battery Pack	
Battery pack voltage	201.6 V
Number of NiMH battery modules in the pack	28
NiMH battery module voltage	7.2 V
NiMH battery module dimensions	11.2 x 0.8 x 4.6 in (285 x 19.6 x 117.8 mm)
NiMH module weight	2.3 lbs (1.04 kg)
NiMH battery pack dimensions	11.7 x 23.2 x 0.42 in (297 x 590 x 10.7 mm)
NiMH battery pack weight	90 lbs (41 kg)

### Components Powered by the HV Battery Pack

- Front Electric Motor
- Power Cables
- Electric Generator
- Inverter/Converter
- A/C Compressor

### HV Battery Pack Recycling

The HV battery pack is recyclable. Contact the nearest Toyota dealer.

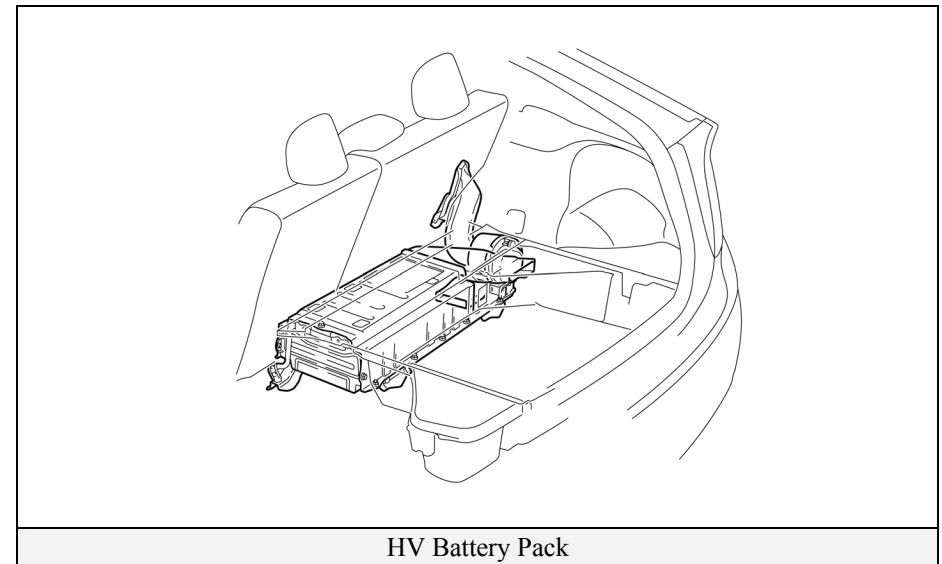

## Solar Ventilation and Remote Air Conditioning Systems

Two newly available options on the 2010 Prius are the solar ventilation system and the remote air conditioning system. These systems are provided for occupant comfort by lowering the inside cabin temperature while the vehicle is shut off and parked.

### Solar Ventilation System

The solar ventilation system uses energy provided by a solar panel built into the roof to operate a fan contained within the air conditioning system. This allows ventilation of the vehicle interior when the vehicle is parked in direct sunlight.

The solar panel consists of 36 poly crystalline silicon cells connected in series. The panel produces a nominal 22 Volts DC and 3.6 Amps (cell temperature 77°F (25°C), sunlight intensity of 1000 W/m<sup>2</sup>). The maximum output of the solar panel is 27 Volts at -22°F (-30°C) and maximum 3.6 Amps in full sunlight intensity. The power output is not connected to the 12 Volt auxiliary battery and will not backfeed the 12 Volt auxiliary battery circuit or SRS circuits.

The solar panel is primarily constructed from glass, potting material, silicon, silver and aluminum compounds, and a back sheet. Aside from the risk of injury due to broken glass, breaking or cutting into the optional solar panel is otherwise not a hazard. Due to the difficulty of breaking or cutting the solar panel, these operations are not recommended.

### NOTE:

If it is necessary to cut the solar panel, in order to stop the modules from generating electricity, at least one solar module must first be covered with a material such as thick fabric that blocks sunlight.

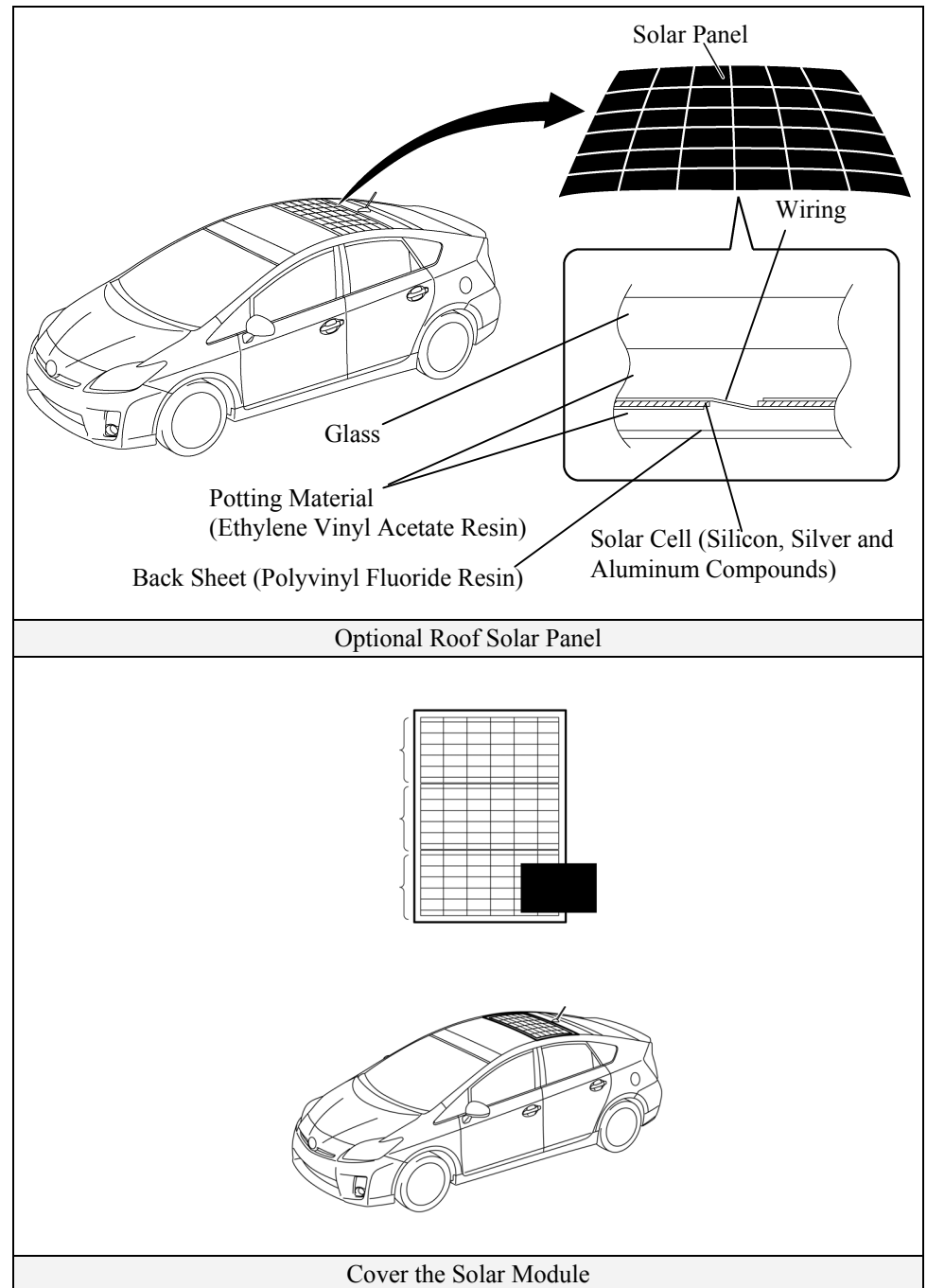



## Solar Ventilation and Remote Air Conditioning Systems (Continued)

### Remote Air Conditioning System

The remote air conditioning system uses energy stored in the High Voltage HV battery pack to operate the high voltage air conditioning compressor. This allows preconditioning of the vehicle interior when the vehicle is shut off and parked. The system is activated remotely by pushing the smart key A/C button and will operate for up to three minutes when certain conditions are met.

The air conditioning system will automatically shut off

- After about 3 minutes has elapsed since operation started.
- When HV battery pack charge level is low.
- When a door is opened.
- When the smart key A/C button is pushed twice within 3 seconds.
- When any of the operating conditions are not met.

As a security feature, unlocked doors are automatically locked when the system is activated.

#### NOTE:

When the optional remote air conditioning system is activated, high voltage power is supplied from the HV battery pack to the air conditioning system, but the vehicle's gasoline engine and electric motor are shut off (the instrument cluster lights are on, but the **READY** indicator is off).

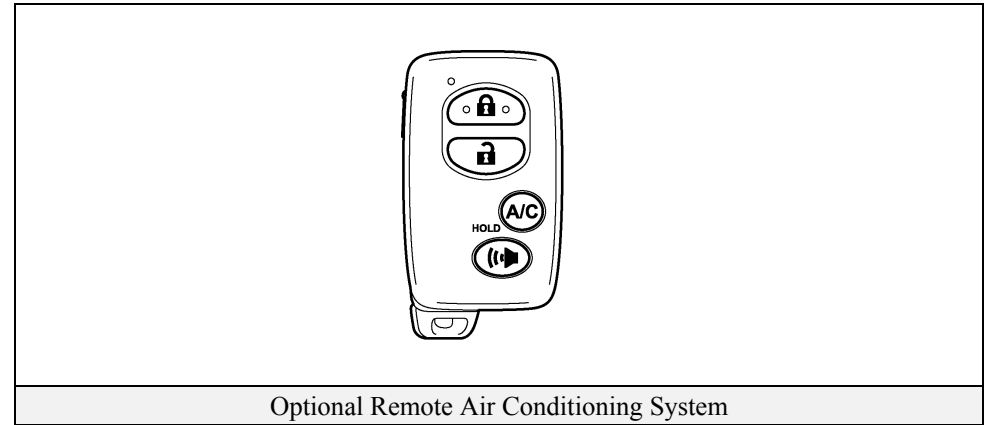

# Low Voltage Battery

## Auxiliary Battery

- The Prius contains a sealed lead-acid 12 Volt battery. The 12 Volt auxiliary battery powers the vehicle's electrical system similar to a conventional vehicle. As with conventional vehicles, the negative terminal of the auxiliary battery is grounded to the metal chassis of the vehicle.
- The auxiliary battery is located in the cargo area. It is concealed by a fabric cover on the right side in the rear quarter panel well.

**NOTE:**

An under hood label shows the location of the HV battery (traction battery) and 12 Volt auxiliary battery.

<p>Remove center deck board</p>	<p>Remove center auxiliary box</p>
<p>Battery Cover</p>	<p>12 Volt Auxiliary Battery Mounted in Cargo Area</p>
<div data-bbox="1102 943 1640 1179"> <p><b>BATTERY LOCATION    EMPLACEMENT DES BATTERIES</b></p> <p>This vehicle has two types of battery:          ① Nickel-Metal Hydride Battery (Traction Battery)          ② Lead Acid Battery (Auxiliary Battery for accessories, lights, etc.)</p> <p>Ce véhicule est équipé de deux types de batteries:          ① Batterie à l'hydrure de nickel métallique (Batterie de traction)          ② Batterie à acide et plomb (Batterie auxiliaire pour les feux, les accessoires, etc.)</p> </div>	
<p>Battery Location Label</p>	

## High Voltage Safety

The HV battery pack powers the high voltage electrical system with DC electricity. Positive and negative orange colored high voltage power cables are routed from the battery pack, under the vehicle floor pan, to the inverter/converter. The inverter/converter contains a circuit that boosts the HV battery voltage from 201.6 to 650 Volts DC. The inverter/converter creates 3-phase AC to power the motor. Power cables are routed from the inverter/converter to each high voltage motor (electric motor, electric generator, and A/C compressor). The following systems are intended to help keep occupants in the vehicle and emergency responders safe from high voltage electricity:

### High Voltage Safety System

- A high voltage fuse ❶ provides short circuit protection in the HV battery pack.
- Positive and negative high voltage power cables ❷ connected to the HV battery pack are controlled by 12 Volt normally open relays ❸. When the vehicle is shut off, the relays stop electrical flow from leaving the HV battery pack.

#### NOTE:

When activated, the optional remote air conditioning system on the 2010 Prius will activate the relays allowing high voltage to flow to the air conditioning compressor while the vehicle is shut off and the **READY** indicator is off. For more information on the remote air conditioning system, see the details on Page 14.

#### **⚠️WARNING:**

*The high voltage system may remain powered for up to 10 minutes after the vehicle is shut off or disabled. To prevent serious injury or death from severe burns or electric shock, avoid touching, cutting, or breaching any orange high voltage power cable or high voltage component.*

- Both positive and negative power cables ❷ are insulated from the metal chassis, so there is no possibility of electric shock when touching the metal chassis.

- A ground fault monitor ❹ continuously monitors for high voltage leakage to the metal chassis while the vehicle is running. If a malfunction is detected, the hybrid vehicle computer ❷ will illuminate the master warning light ⚠️ in the instrument cluster and indicate “Check Hybrid System” on the multi-information display.

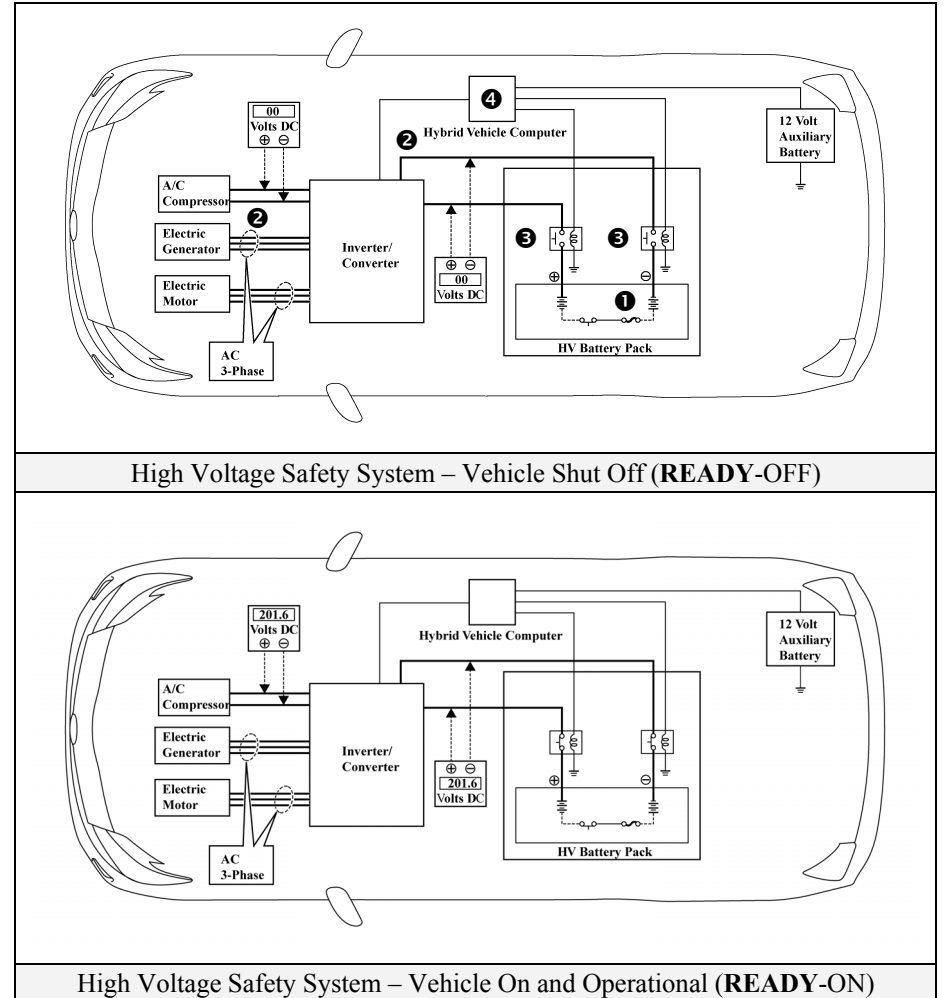

## SRS Airbags & Seat Belt Pretensioners

### Standard Equipment

- Electronic frontal impact sensors (2) are mounted in the engine compartment ❶ as illustrated.
- Front seat belt pretensioners are mounted near the base of the B-pillars ❷.
- A frontal driver airbag ❸ is mounted in the steering wheel hub.
- A frontal twin-chamber shaped dual stage passenger airbag ❹ is integrated into the dashboard and deploys through the top of the dashboard.
- The SRS computer ❺, which contains an impact sensor, is mounted on the floor pan underneath the instrument panel, forward of the shift lever.
- Front electronic side impact sensors (2) are mounted near the base of the B-pillars. ❻
- Rear electronic side impact sensors (2) are mounted near the base of the C-pillars. ❼
- Front seat side airbags ❸ are mounted in the front seatbacks.
- Side curtain airbags ❹ are mounted along the outer edge inside the roof rails.
- Driver knee airbags ❷ are mounted on the lower portion of the dash.
- Active (mechanical non-pyrotechnic) front seat headrests (see description on page 25).

### Optional Equipment

- The optional pre-collision safety system contains a radar sensory system and an electric motor-pyrotechnic pretensioner system. During a pre-collision event, an electric motor in the pretensioners retracts the front seatbelt. When conditions stabilize the electric motor will reverse itself. When the airbags deploy, the pyrotechnic pretensioners function normally.

### ⚠ WARNING:

*The SRS may remain powered for up to 90 seconds after the vehicle is shut off or disabled. To prevent serious injury or death from unintentional SRS deployment, avoid breaching the SRS components.*

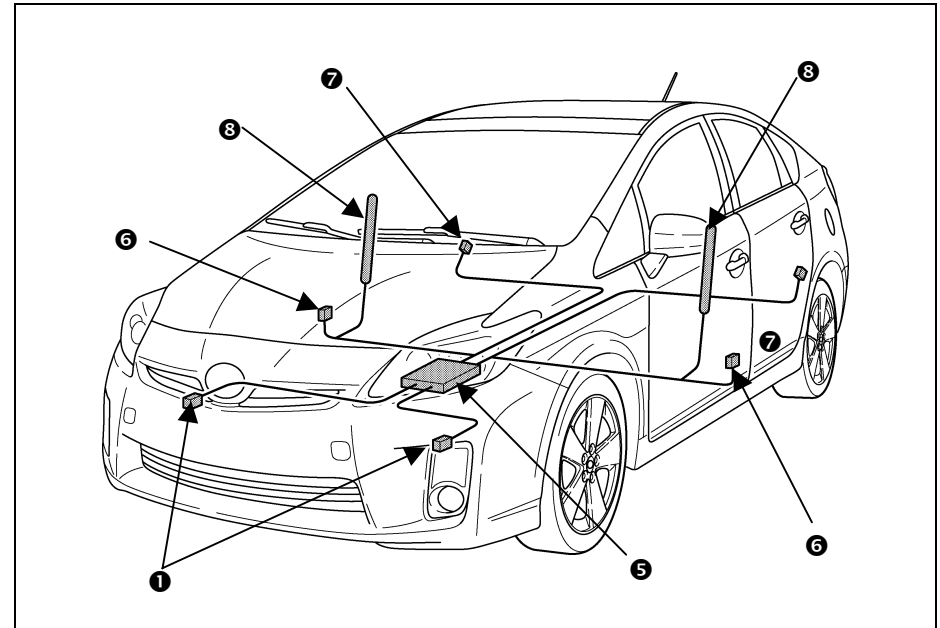

Electronic Impact Sensors and Side Airbags

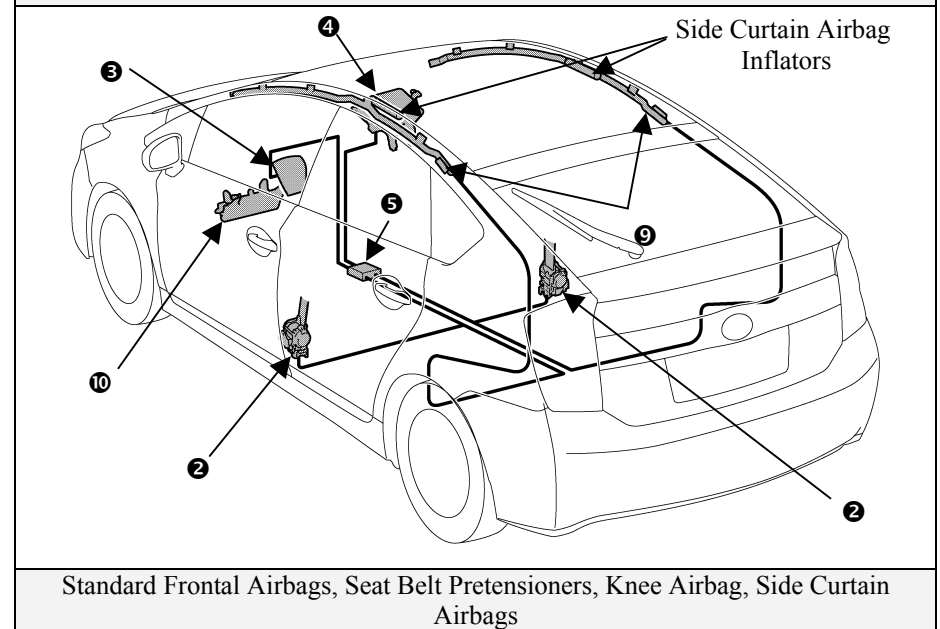

Standard Frontal Airbags, Seat Belt Pretensioners, Knee Airbag, Side Curtain Airbags

## SRS Airbags & Seat Belt Pretensioners (Continued)

### NOTE:

The front seatback mounted side airbags and the side curtain airbags may deploy independently of each other.

The knee airbag deploys simultaneously with the frontal airbags.

The Prius is equipped with a standard front passenger occupant classification system that may prohibit the deployment of the front passenger frontal airbag, knee airbag, seatback mounted side airbag, and seat belt pretensioners. If the passenger occupant classification system prohibits deployment during an SRS event, the passenger SRS will not re-arm nor deploy.

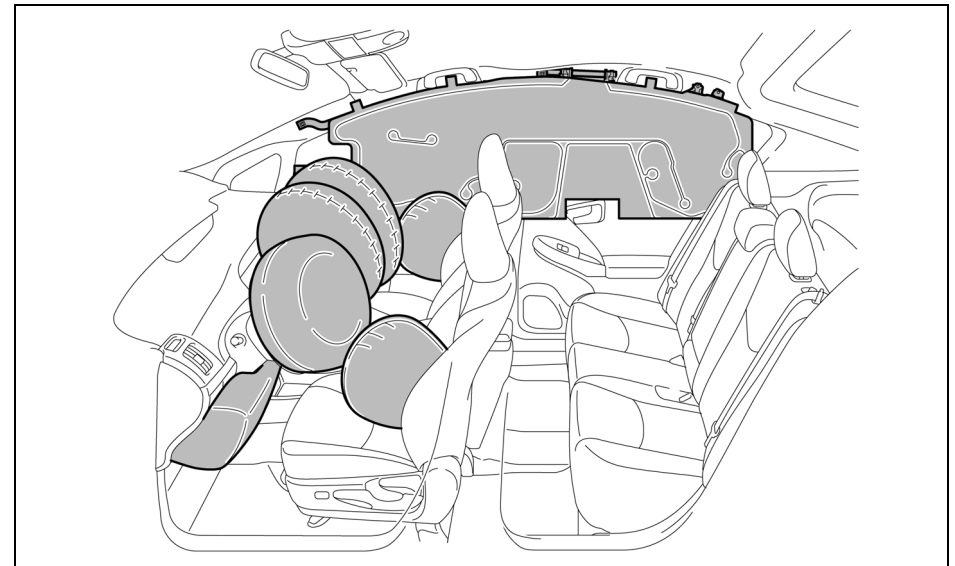
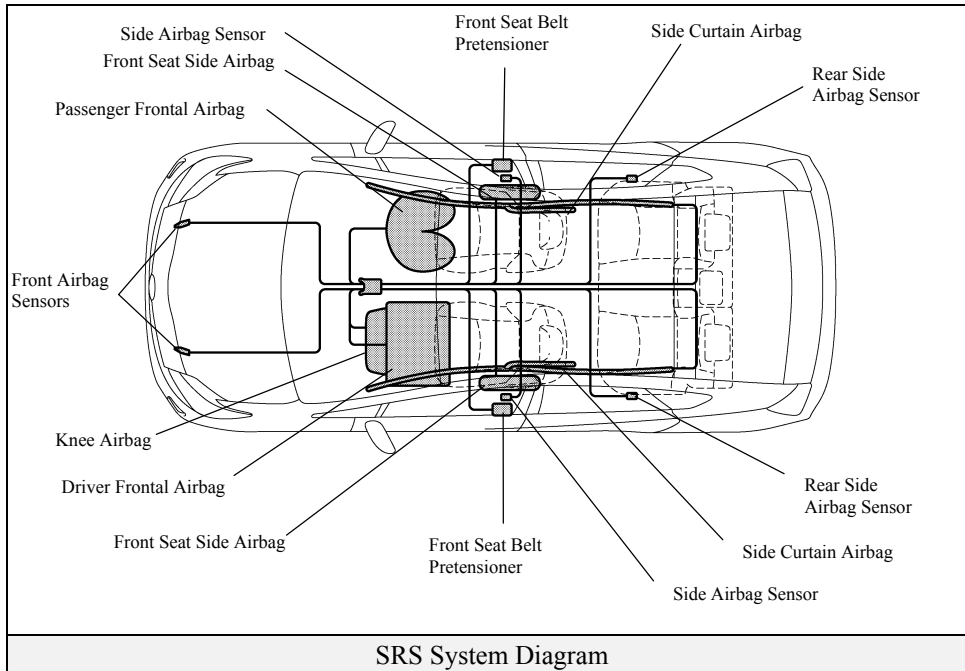

Frontal, Knee, Front and Rear Seatback Mounted Side, Side Curtain Airbags.

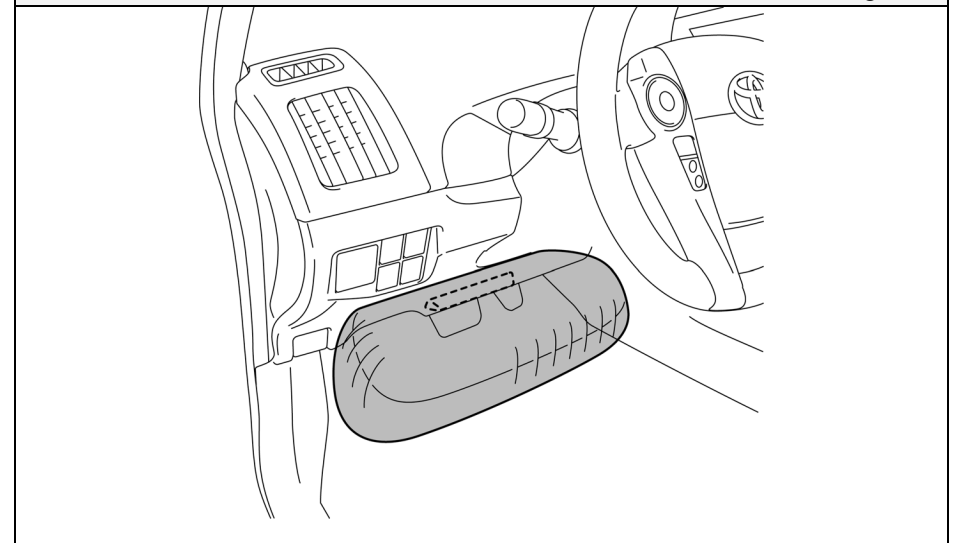

Driver Knee Airbag and Inflator

## Emergency Response

On arrival, emergency responders should follow their standard operating procedures for vehicle incidents. Emergencies involving the Prius may be handled like other automobiles except as noted in these guidelines for Extrication, Fire, Overhaul, Recovery, Spills, First Aid, and Submersion.

### ⚠️ WARNING:

- *Never assume the Prius is shut off simply because it is silent.*
- *Always observe the instrument cluster for the **READY** indicator status to verify whether the vehicle is on or shut off. The vehicle and optional remote air conditioning system are shut off when the **READY** indicator is off and the instrument cluster lights are out.*
- *Failure to shut off and disable the vehicle before emergency response procedures are performed may result in serious injury or death from the unintentional deployment of the SRS or severe burns and electric shock from the high voltage electrical system.*

### Extrication

- **Immobilize Vehicle**  
Chock wheels and set the parking brake.  
Push the **P** switch to engage park.
- **Disable Vehicle**  
Performing either of the following two procedures will shut the vehicle off and disable the HV battery pack, SRS, optional remote air conditioning system, and gasoline fuel pump.

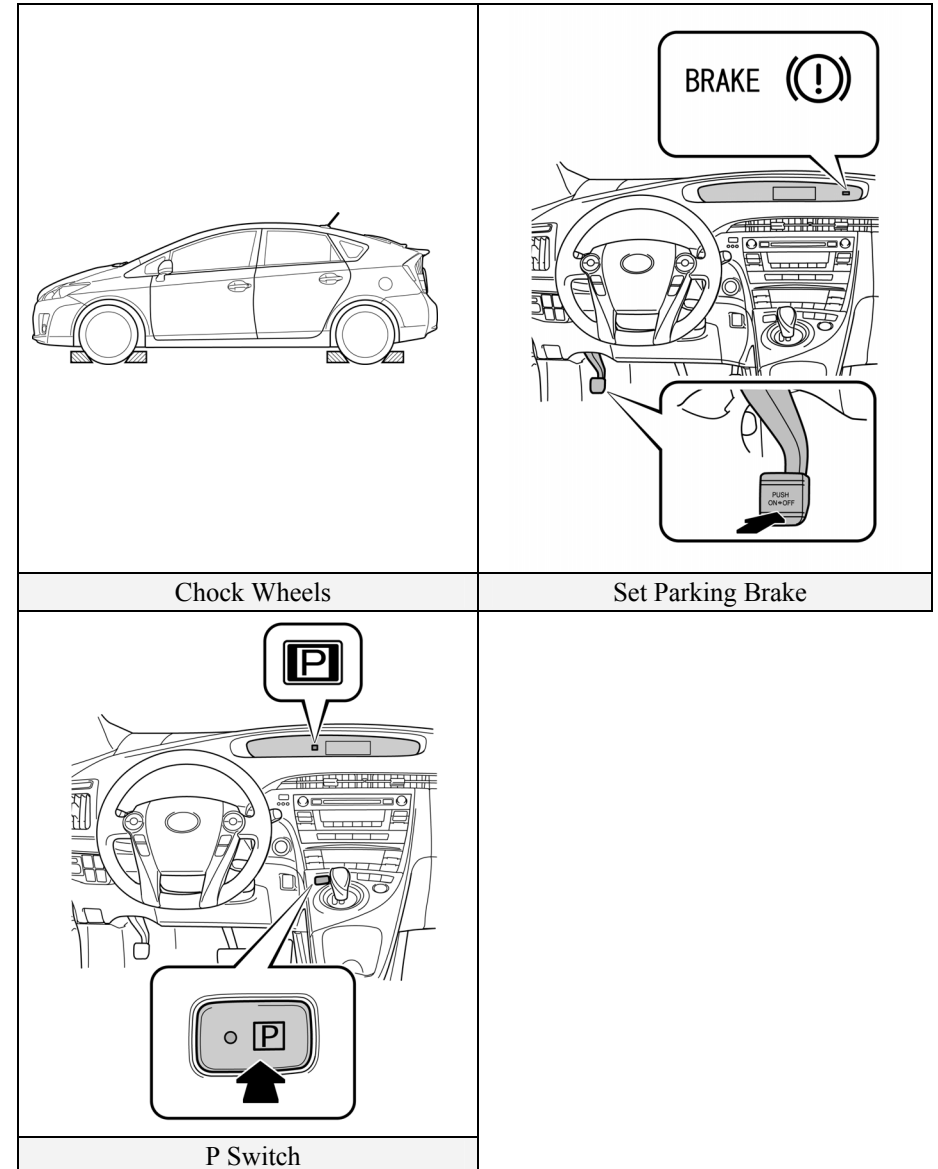

## Emergency Response (Continued)

### Extrication (Continued)

#### Procedure #1

1. Confirm the status of the **READY** indicator in the instrument cluster. If the **READY** indicator is illuminated, the vehicle is on and operational.

#### NOTE:

For vehicles with the optional remote air conditioning system, although the **READY** indicator is off, high voltage may be supplied to the air conditioning system if the instrument cluster lights are on. Be sure to perform the remaining steps of this procedure.

2. Shut off the vehicle by pushing the power button once.
3. The vehicle is already shut off if the instrument cluster lights are not illuminated. Do **not** push the power button because the vehicle may start.
4. If the smart key is easily accessible, keep it at least 16 feet (5 meters) away from the vehicle. Do **not** push the A/C button on the key, because this may energize the high voltage circuit used for the optional remote air conditioning system.
5. Disconnect the 12 Volt auxiliary battery under the cover in the cargo area to prevent accidental restarting of the vehicle and optional remote air conditioning system.

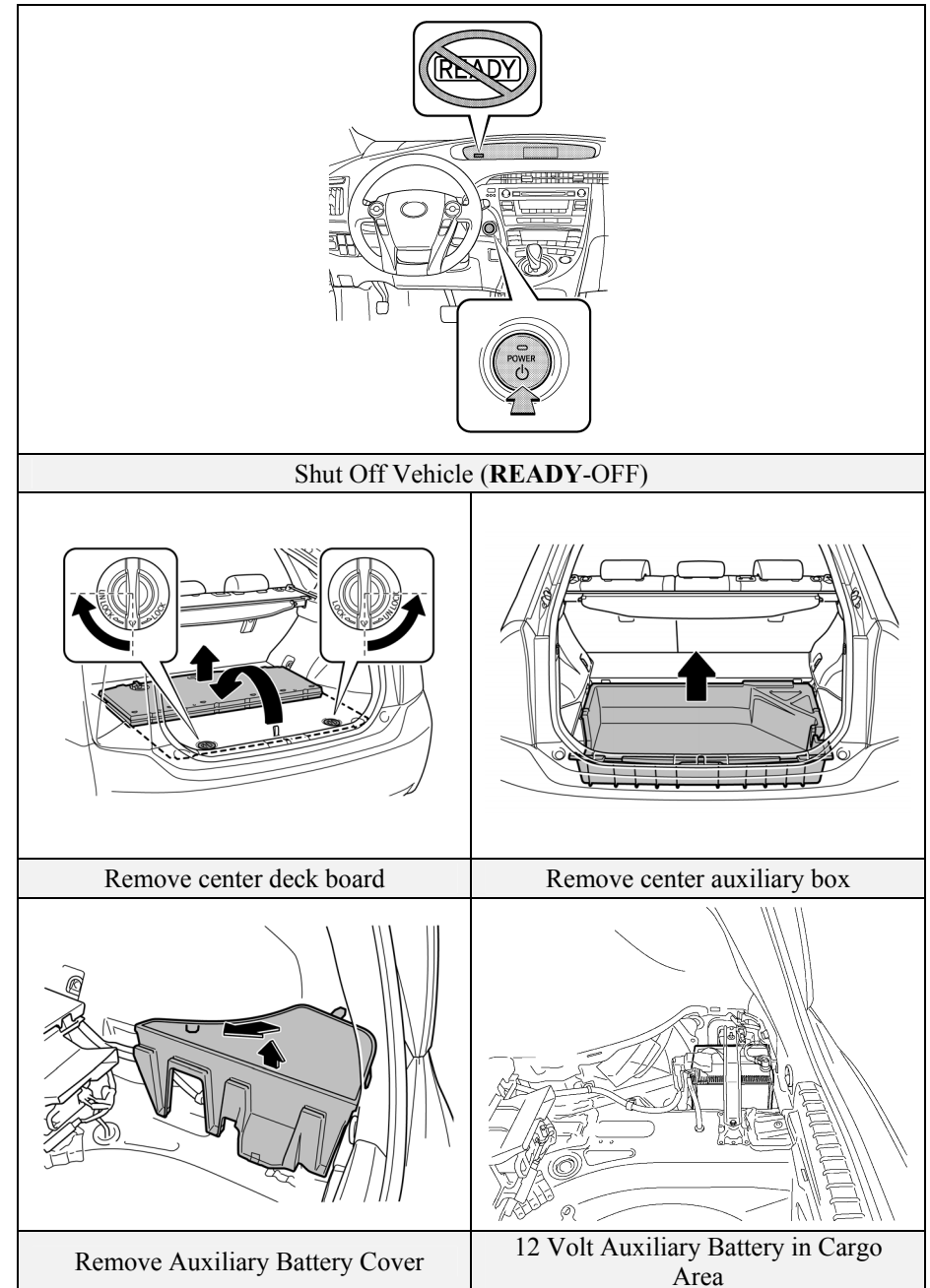

## Emergency Response (Continued)

### Extrication (Continued)

#### Procedure #2 (Alternate if power button is inaccessible)

1. Open the hood.
2. Remove the fuse box cover.
3. Remove the **IGCT** fuse (30A green colored) and **AM2** fuse (7.5A orange colored) in the engine compartment fuse box (refer to illustration). If the correct fuse cannot be recognized, pull all fuses in the fuse box.
4. Disconnect the 12 Volt auxiliary battery under the cover in the cargo area.

#### NOTE:

Before disconnecting the 12 Volt auxiliary battery, if necessary, lower the windows, unlock the doors and open the back door as required. Once the 12 Volt auxiliary battery is disconnected, power controls will not operate.

#### ⚠ WARNING:

- *The high voltage system may remain powered for up to 10 minutes after the vehicle is shut off or disabled. To prevent serious injury or death from severe burns or electric shock, avoid touching, cutting, or breaching any orange high voltage power cable or high voltage component.*
- *The SRS may remain powered for up to 90 seconds after the vehicle is shut off or disabled. To prevent serious injury or death from unintentional SRS deployment, avoid breaching the SRS components.*
- *If none of the disabling procedures can be performed, proceed with caution as there is no assurance that the high voltage electrical system, SRS, optional remote air conditioning system, or fuel pump are disabled.*
- *The high voltage motor compressor for the optional remote air conditioning system can be operated when the hybrid system is off by pressing a button on the key. When disabling the vehicle or unlocking the doors, do not press the A/C button on the key. Make sure to disconnect the 12 Volt auxiliary battery to prevent inadvertent operation of the optional remote air conditioning.*

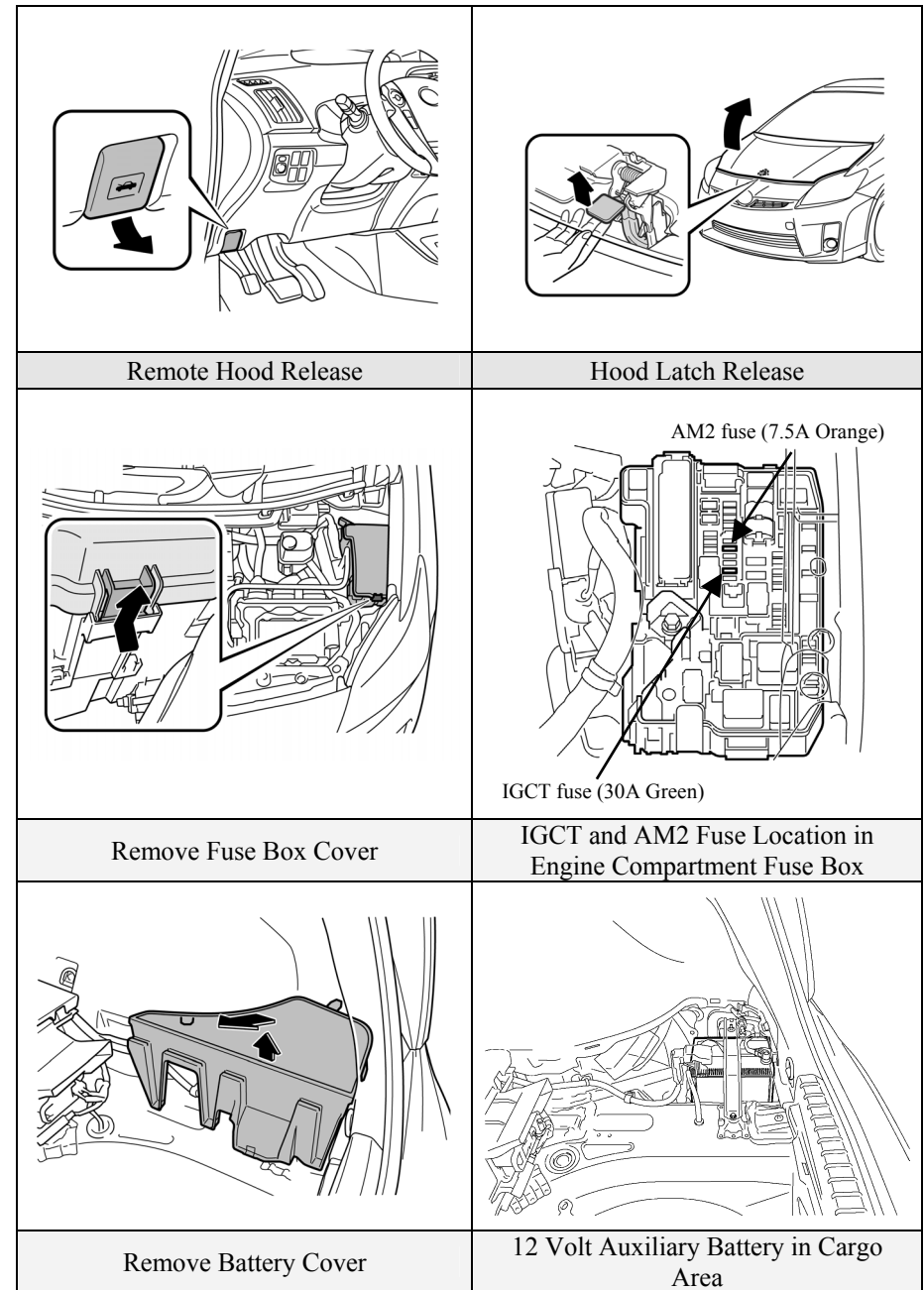



## Emergency Response (Continued)

### Extrication (Continued)

- Stabilize Vehicle

Crib at (4) points directly under the front and rear pillars.  
Do not place cribbing under the high voltage power cables, exhaust system, or fuel system.

NOTE:

The Prius is equipped with a tire pressure warning system that by design prevents pulling the metal valve stem with integral transmitter from the wheel. Snapping the valve stem with pliers or removing the valve cap and Schrader valve will release the air in the tire.

- Access Patients

Glass Removal

Use normal glass removal procedures as required.

SRS Awareness

Responders need to be cautious when working in close proximity to undeployed airbags and seat belt pretensioners. Front dual stage airbags automatically ignite both stages within a fraction of a second.

Door Removal/Displacement

Doors can be removed by conventional rescue tools such as hand, electric, and hydraulic tools. In certain situations, it may be easier to pry back the vehicle body to expose and unbolt the hinges.

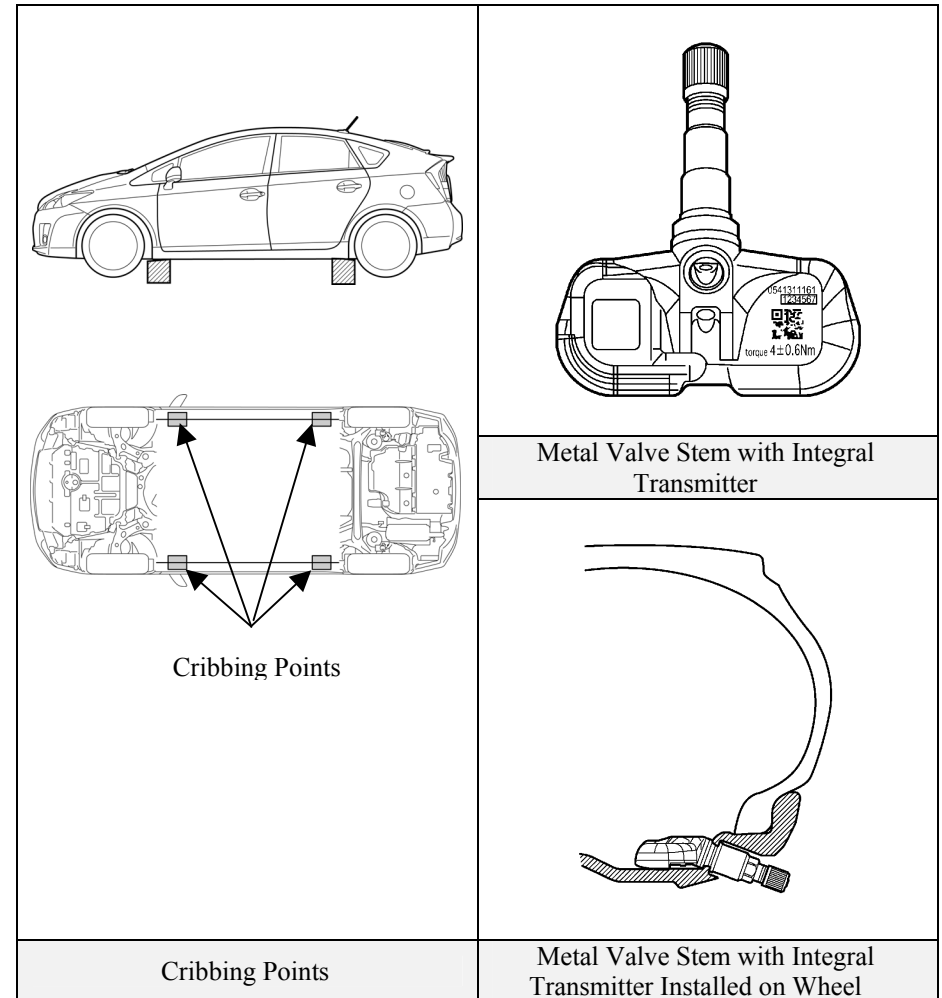

## Emergency Response (Continued)

### Extrication (Continued)

#### Roof Removal

The Prius is equipped with side curtain airbags. When undeployed, total roof removal is not recommended. Patient access through the roof can be performed by cutting the roof center section inboard of the roof rails as illustrated. This would avoid breaching the side curtain airbags, inflators, and wiring harness. Although cutting the pillars for total roof removal is not recommended, if the pillars must be cut, at least one solar module must first be covered with a material such as thick fabric that blocks sunlight to reduce the possibility of inadvertent SRS deployment.

Aside from the risk of injury due to broken glass, breaking or cutting into the optional solar panel is otherwise not a hazard. Due to the difficulty of breaking or cutting the solar panel, these operations are not recommended.

#### NOTE:

- The side curtain airbags may be identified as illustrated on this page (additional component details on page 17).
- The optional solar ventilation system may be identified as illustrated on page 13 (additional system details are also provided).
- If it is necessary to stop the modules from generating electricity, at least one solar module must first be covered with a material such as thick fabric that blocks sunlight.

#### Dash Displacement

The Prius is equipped with side curtain airbags. When undeployed, total roof removal is not recommended to avoid breaching the side curtain airbags, inflators, and wiring harness. As an alternative, dash displacement may be performed by using a Modified Dash Roll.

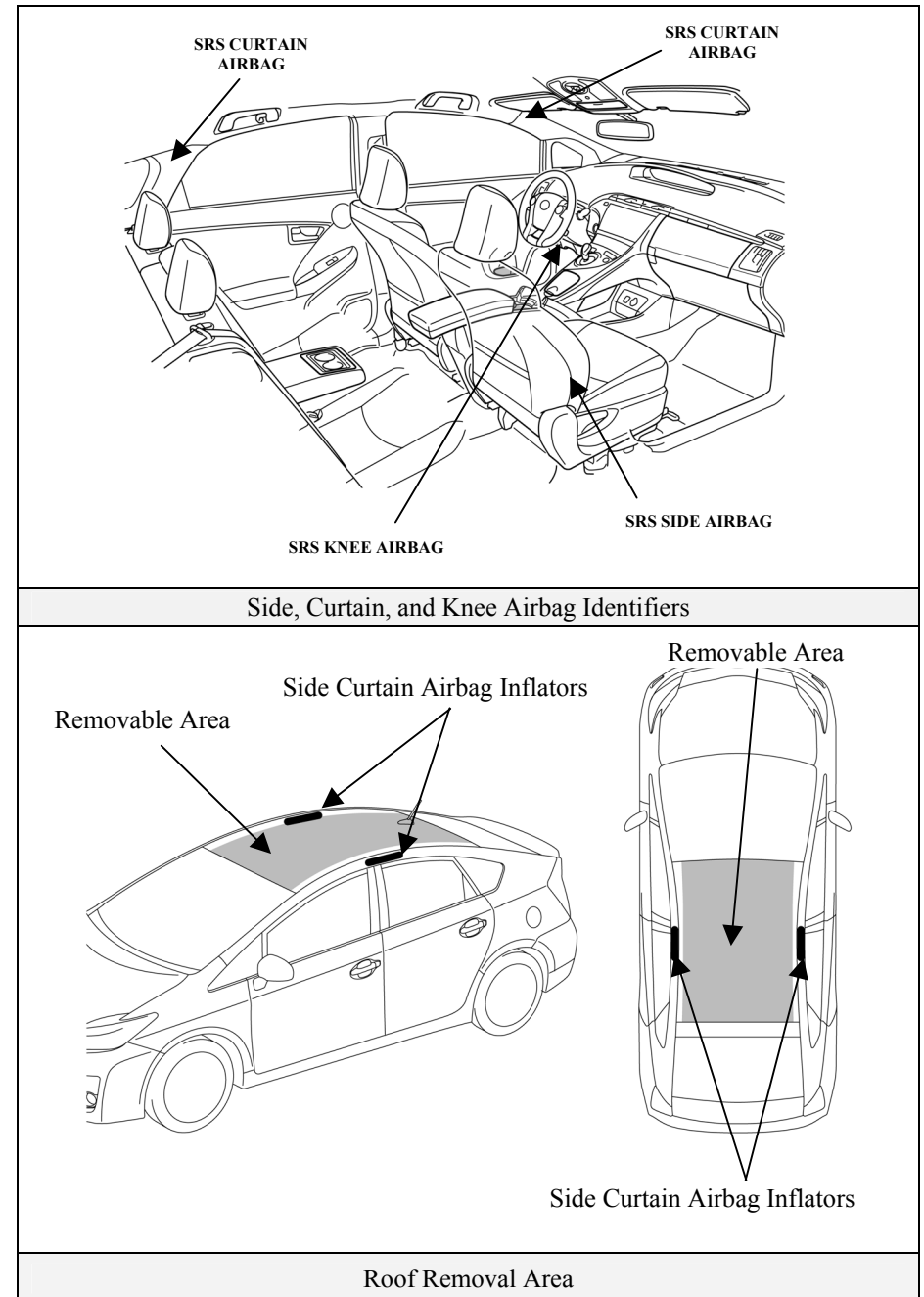

## Emergency Response (Continued)

### Extrication (Continued)

#### Rescue Lift Air Bags

Responders should not place cribbing or rescue lift air bags under the high voltage power cables, exhaust system, or fuel system.

#### Repositioning Steering Wheel and Front Seats

Telescopic steering wheel and seat controls are shown in the illustrations.

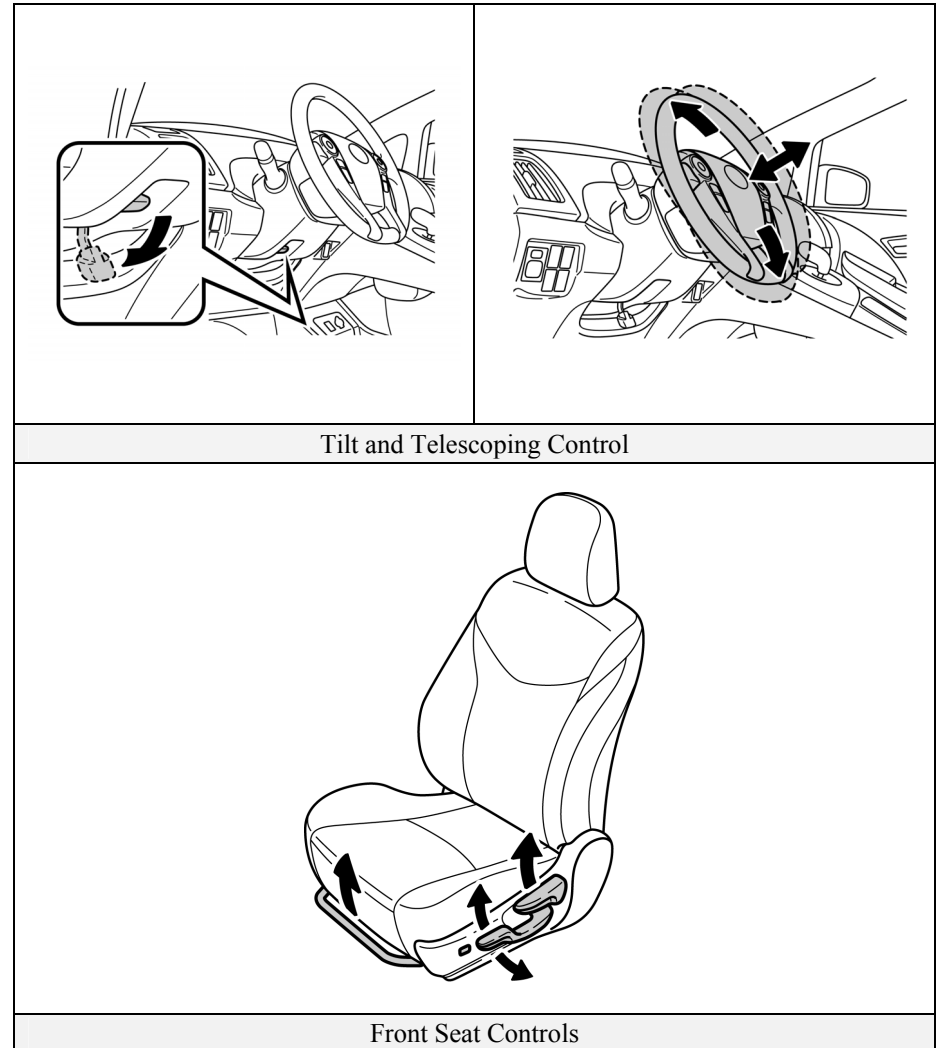

## Emergency Response (Continued)

### Extrication (Continued)

#### Active Headrest Removal

The Prius is equipped with active headrests, located in both front seatbacks. The active headrests are mechanical non-pyrotechnic head supports that are designed to reduce neck injuries in the event of a rear collision.

No special methods are required to remove the headrests. Push the release button and lift to remove the headrest.

#### NOTE:

The Prius is equipped with an optional electrochromic auto dimming rear view mirror. The mirror contains a minimal amount of transparent gel sealed between two glass plates that will not normally leak.

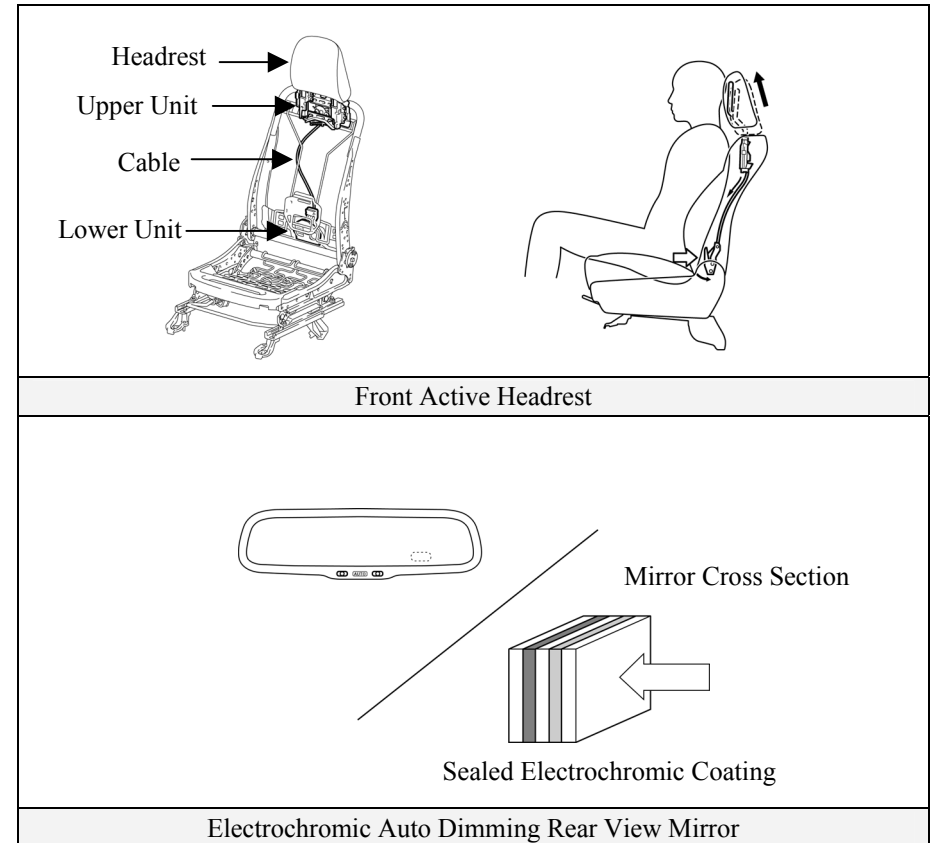

## Emergency Response (Continued)

### Fire

Approach and extinguish a fire using proper vehicle fire fighting practices as recommended by NFPA, IFSTA, or the National Fire Academy (USA).

- Extinguishing Agent  
Water has been proven to be a suitable extinguishing agent.
- Initial Fire Attack  
Perform a fast, aggressive fire attack.  
Divert the runoff from entering watershed areas.  
Attack teams may not be able to identify a Prius until the fire has been knocked down and overhaul operations have commenced.
- Fire in the HV Battery Pack  
Should a fire occur in the NiMH HV battery pack, attack crews should utilize a water stream or fog pattern to extinguish any fire within the vehicle except for the HV battery pack.

#### **WARNING:**

- *The NiMH battery electrolyte is a caustic alkaline (pH 13.5) that is damaging to human tissues. To avoid injury by coming in contact with the electrolyte, wear proper personal protective equipment.*
- *The battery modules are contained within a metal case and accessibility is limited.*
- *To avoid serious injury or death from severe burns or electric shock, **never** breach or remove the high voltage battery pack cover under any circumstance including fire.*

When allowed to burn themselves out, the Prius NiMH battery modules burn rapidly and can quickly be reduced to ashes except for the metal.

### *Offensive Fire Attack*

Normally, flooding an NiMH HV battery pack with copious amounts of water at a safe distance will effectively control the HV battery pack fire by cooling the adjacent NiMH battery modules to a point below their ignition temperature. The remaining modules on fire, if not extinguished by the water, will burn themselves out.

However, flooding the Prius HV battery pack is not recommended due to the battery case design and location preventing the responder from properly applying water through the available vent openings safely. Therefore, it is recommended that the incident commander allow the Prius HV battery pack to burn itself out.

### *Defensive Fire Attack*

If the decision has been made to fight the fire using a defensive attack, the fire attack crew should pull back a safe distance and allow the NiMH battery modules to burn themselves out. During this defensive operation, fire crews may utilize a water stream or fog pattern to protect exposures or to control the path of smoke.

## Emergency Response (Continued)

### Overhaul

During overhaul, immobilize and disable the vehicle if not already done. Refer to illustrations on page 20, 21 and 22. The HV battery cover should *never* be breached or removed under any circumstances including fire. Doing so may result in severe electrical burns, shock, or electrocution.

- Immobilize Vehicle
  - Chock wheels and set the parking brake.
  - Push the **P** switch to engage park.
- Disable Vehicle
  - Performing either of the following two procedures will shut the vehicle off and disable the HV battery pack, SRS, and gasoline fuel pump.

#### Procedure #1

1. Confirm the status of the **READY** indicator in the instrument cluster. If the **READY** indicator is illuminated, the vehicle is on and operational.

#### NOTE:

For vehicles with the optional remote air conditioning system, although the **READY** indicator is off, high voltage may be supplied to the air conditioning system if the instrument cluster lights are on. Be sure to perform the remaining steps of this procedure.

2. Shut off the vehicle by pushing the power button once.
3. The vehicle is already shut off if the instrument cluster lights are not illuminated. Do **not** push the power button because the vehicle may start.
4. If the smart key is easily accessible, keep it at least 16 feet (5 meters) away from the vehicle. Do not push the A/C button on the key, because this may energize the high voltage circuit used for the optional remote air conditioning system.
5. Disconnect the 12 Volt auxiliary battery under the cover in the cargo area to prevent accidental restarting of the vehicle and optional remote air conditioning system.

#### Procedure #2 (Alternate if power button is inaccessible)

1. Open the hood and remove the fuse box cover.

2. Remove the **IGCT** fuse (30A green colored) and **AM2** fuse (7.5A orange colored) in the engine compartment fuse box as illustrated on page 21. If the correct fuse cannot be recognized, pull all fuses in the fuse box.
3. Disconnect the 12 Volt auxiliary battery under the cover in the cargo area.

#### NOTE:

Before disconnecting the 12 Volt auxiliary battery, if necessary, lower the windows, unlock the doors and open the back door as required. Once the 12 Volt auxiliary battery is disconnected, power controls will not operate.

#### **WARNING:**

- *The high voltage system may remain powered for up to 10 minutes after the vehicle is shut off or disabled. To prevent serious injury or death from severe burns or electric shock, avoid touching, cutting, or breaching any orange high voltage power cable or high voltage component.*
- *The SRS may remain powered for up to 90 seconds after the vehicle is shut off or disabled. To prevent serious injury or death from unintentional SRS deployment, avoid breaching the SRS components.*
- *If none of the disabling procedures can be performed, proceed with caution as there is no assurance that the high voltage electrical system, SRS, optional remote air conditioning or fuel pump are disabled.*
- *The high voltage motor compressor for the optional remote air conditioning system can be operated when the hybrid system is off by pressing a button on the key. When disabling the vehicle or unlocking the doors, do not press the A/C button on the key. Make sure to disconnect the 12 Volt auxiliary battery to prevent inadvertent operation of the remote air conditioning.*

#### Recovering/Recycling of NiMH HV Battery Pack

Clean up of the HV battery pack can be accomplished by the vehicle recovery crew without further concern of runoff or spillage. For information regarding recycling of the HV battery pack, contact the nearest Toyota dealer.

## Emergency Response (Continued)

### Spills

The Prius contains the same common automotive fluids used in other non-hybrid Toyota vehicles, with the exception of the NiMH electrolyte used in the HV battery pack. The NiMH battery electrolyte is a caustic alkaline (pH 13.5) that is damaging to human tissues. The electrolyte, however, is absorbed in the cell plates and will not normally spill or leak out even if a battery module is cracked. A catastrophic crash that would breach both the metal battery pack case and a battery module would be a rare occurrence.

Similar to the use of baking soda to neutralize a lead-acid battery electrolyte spill, a dilute boric acid solution or vinegar can be used to neutralize a NiMH battery electrolyte spill.

### NOTE:

Electrolyte leakage from the HV battery pack is unlikely due to its construction and the amount of available electrolyte contained within the NiMH modules. Any spillage would not warrant a declaration as a hazardous material incident. Responders should follow the recommendations as outlined in this emergency response guide.

In an emergency, manufacturer's Material Safety Data Sheets (MSDS):

- Handle NiMH electrolyte spills using the following Personal Protective Equipment (PPE):
  - Splash shield or safety goggles. Fold down helmet shields are not acceptable for acid or electrolyte spills.
  - Rubber, latex or nitrile gloves.
  - Apron suitable for alkaline.
  - Rubber boots.
- Neutralize NiMH Electrolyte
  - Use a boric acid solution or vinegar.
  - Boric acid solution - 800 grams boric acid to 20 liters water or 5.5 ounces boric acid to 1 gallon of water.

### First Aid

Emergency responders may not be familiar with a NiMH electrolyte exposure when rendering aid to a patient. Exposure to the electrolyte is unlikely except in a catastrophic crash or through improper handling. Utilize the following guidelines in the event of exposure.

#### **WARNING:**

*The NiMH battery electrolyte is a caustic alkaline (pH 13.5) that is damaging to human tissues. To avoid injury by coming in contact with the electrolyte, wear proper personal protective equipment.*

- Wear Personal Protective Equipment (PPE)
  - Splash shield or safety goggles. Fold down helmet shields are not acceptable for acid or electrolyte spills.
  - Rubber, latex or nitrile gloves.
  - Apron suitable for alkaline.
  - Rubber boots.
- Absorption
  - Perform gross decontamination by removing affected clothing and properly disposing of the garments.
  - Rinse the affected areas with water for 20 minutes.
  - Transport patients to the nearest emergency medical care facility.
- Inhalation in Non-Fire Situations
  - No toxic gases are emitted under normal conditions.
- Inhalation in Fire Situations
  - Toxic gases are given off as by-products of combustion. All responders in the Hot Zone should wear the proper PPE for fire fighting including SCBA.
  - Move a patient from the hazardous environment to a safe area and administer oxygen.
  - Transport patients to the nearest emergency medical care facility.
- Ingestion
  - Do not induce vomiting.
  - Allow the patient to drink large quantities of water to dilute the electrolyte (never give water to an unconscious person).

## **Emergency Response (Continued)**

### First Aid (Continued)

If vomiting occurs spontaneously, keep the patient's head lowered and forward to reduce the risk of asphyxiation.

Transport patients to the nearest emergency medical care facility.

### Submersion

A submerged hybrid vehicle does not have high voltage potential on the metal vehicle body, and is safe to touch.

#### Access Patients

Responders can access the patient and perform normal extrication procedures. High voltage orange color coded power cables and high voltage components should never be touched, cut, or breached.

#### Vehicle Recovery

If a hybrid vehicle is fully or partially submerged in water, emergency responders may not be able to determine if the vehicle has been automatically disabled. The Prius may be handled by following these recommendations:

1. Remove the vehicle from the water.
2. Cover the one solar module with a material such as thick fabric that blocks sunlight (vehicles with the optional solar ventilation system).
3. Drain the water from the vehicle if possible.
4. Follow the immobilizing and disabling procedures on page 20, 21 and 22.

#### NOTE:

- The optional solar ventilation system may be identified as illustrated on page 13 (additional system details are also provided).
- When parts related to the electronic gearshift selector, P switch or hybrid system are damaged due to submersion, it may not be possible to shift the transaxle out of park.



## Roadside Assistance

The Prius utilizes an electronic gearshift selector and an electronic **P** position switch for park. If the 12-Volt auxiliary battery is discharged or disconnected, the vehicle cannot be started nor can it be shifted out of park. If discharged, the 12-Volt auxiliary battery can be jump started to allow vehicle starting and shifting out of park (P) position. Most other roadside assistance operations may be handled like conventional Toyota vehicles.

### Towing

The Prius is a front wheel drive vehicle and it **must** be towed with the front wheels off the ground. Failure to do so may cause serious damage to Hybrid Synergy Drive components.

- The vehicle may be shifted out of **Park** into **Neutral** by turning the ignition-on and **READY**-on modes. To select **Neutral**, it is necessary to hold the shift selector in the N position for approximately 0.5 seconds.
- If the 12-Volt auxiliary battery is discharged, the vehicle will not start and shifting out of park is not possible. There is no manual override except to jump start the vehicle, refer to the Jump Starting on page 33.
- If a tow truck is not available, in an emergency the vehicle may be temporarily towed using a cable or chain secured to the emergency towing eyelet or rear tow hook. This should only be attempted on hard, paved roads for short distances at low speeds. The eyelet is located with the tools in the cargo area of the vehicle, refer to the illustration on page 32.

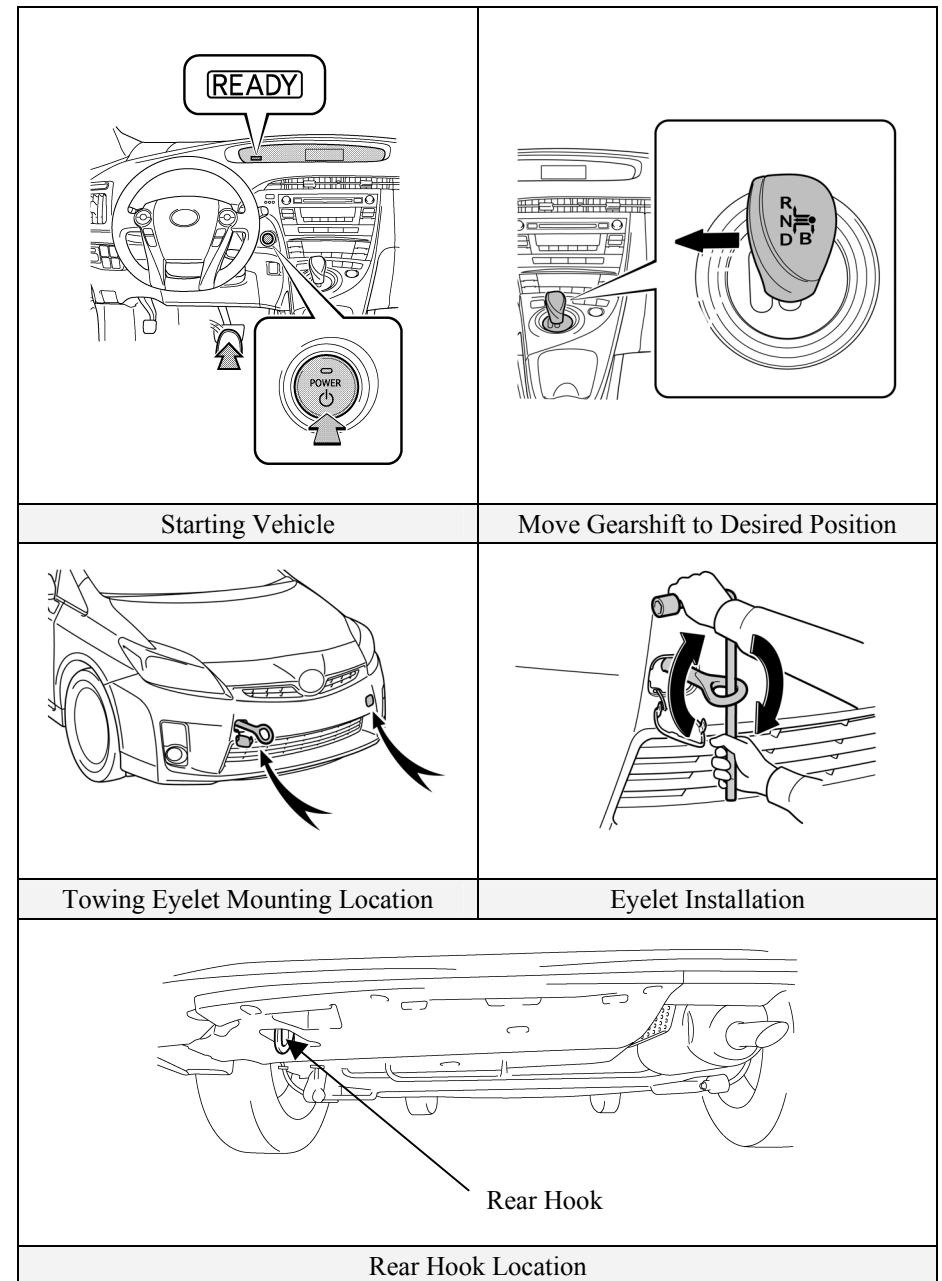

## Roadside Assistance (Continued)

### Electric Back Door Opener

The Prius is equipped with an electric back door opener. In the event of 12 Volt power loss, the back door cannot be opened from the outside of the vehicle.

The electric back door can be opened manually using the release as shown in the illustration.

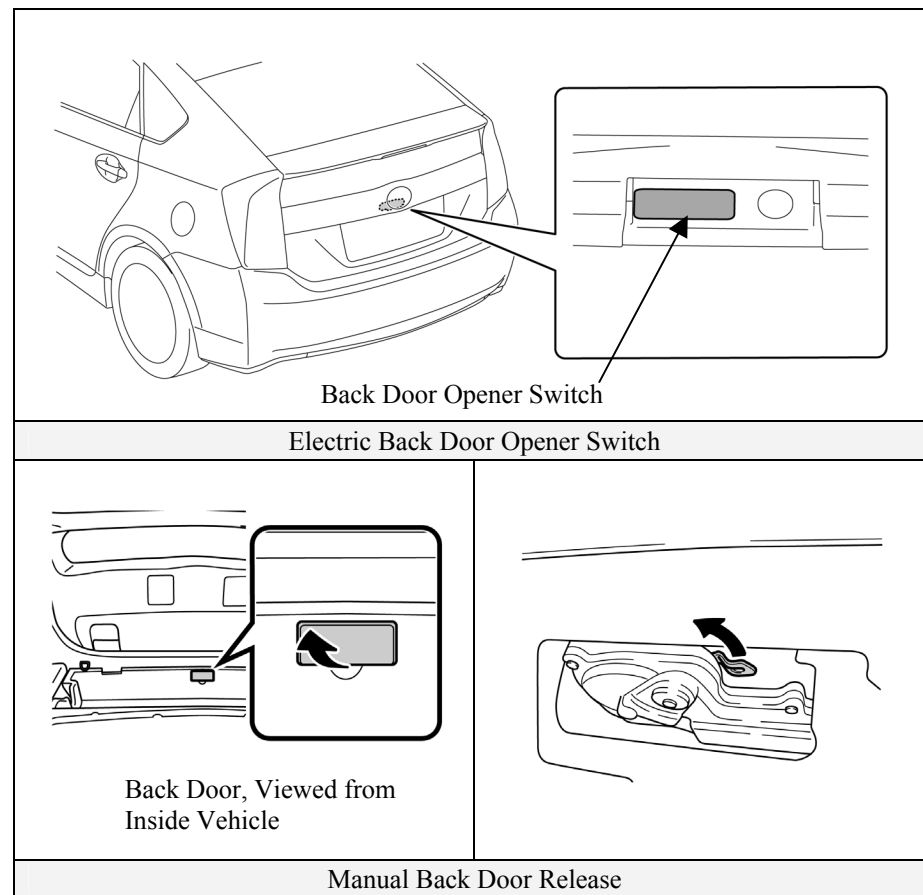

## Roadside Assistance (Continued)

### Spare Tire

The jack, tools, towing eyelet and spare tire are provided as shown.

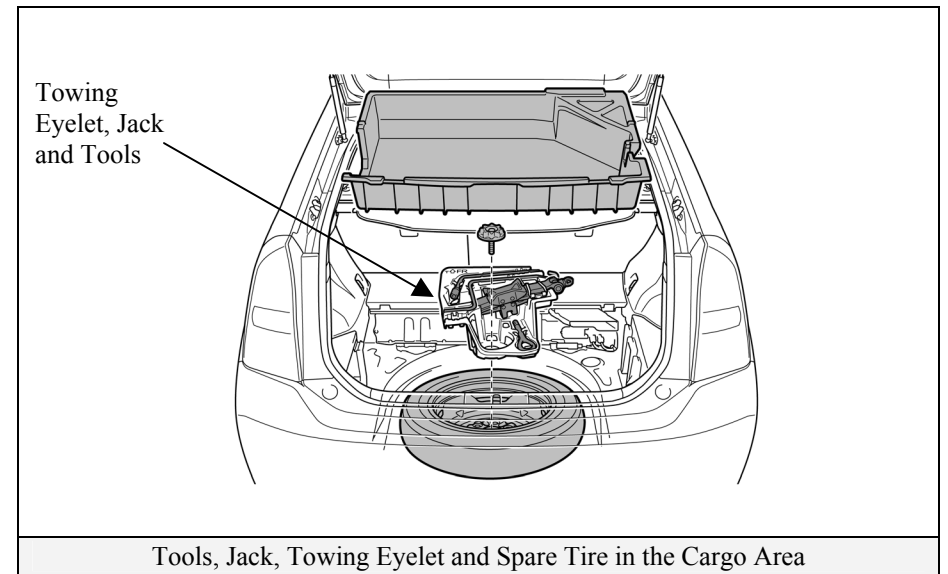

## Roadside Assistance (Continued)

### Jump Starting

The 12 Volt auxiliary battery may be jump started if the vehicle does not start and the instrument cluster gauges are dim or off after depressing the brake pedal and pushing the power button.

The 12 Volt auxiliary battery is located in the cargo area. If the 12 volt auxiliary battery is discharged, the rear back door cannot be opened. Instead, the vehicle can be jump started by accessing the remote positive 12 volt auxiliary battery terminal in the engine compartment fuse box.

- Open the hood, remove the fuse box cover, and open the positive terminal cover.
- Connect the positive jumper cable to the positive terminal.
- Connect the negative jumper cable to a solid ground.
- Place the smart key in proximity to the interior of the vehicle, depress the brake pedal, and push the power button.

#### NOTE:

If the vehicle does not recognize the smart key after connecting the booster battery to the vehicle, open and close the driver door when the vehicle is shut off.

If the smart key internal battery is dead, touch the Toyota emblem side of the smart key to the power button during the start sequence. See the instructions and illustrations on page 9 for more details.

- The high voltage HV battery pack cannot be jump started.

### Immobilizer

The Prius is equipped with a standard immobilizer system.

- The vehicle can be started only with a registered smart key.

